

→ sala classificação de risco

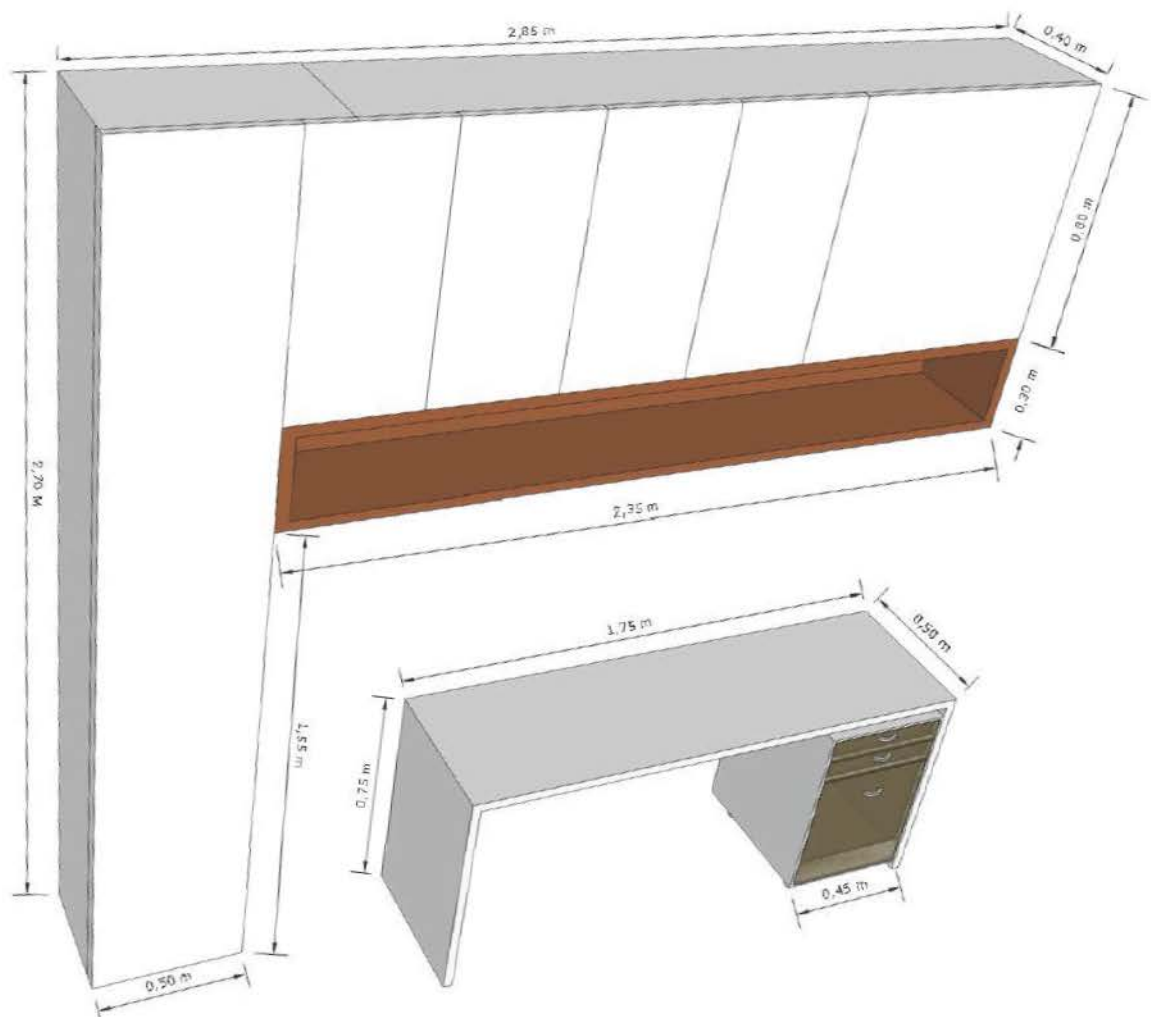

CONSULTÓRIO COMUM

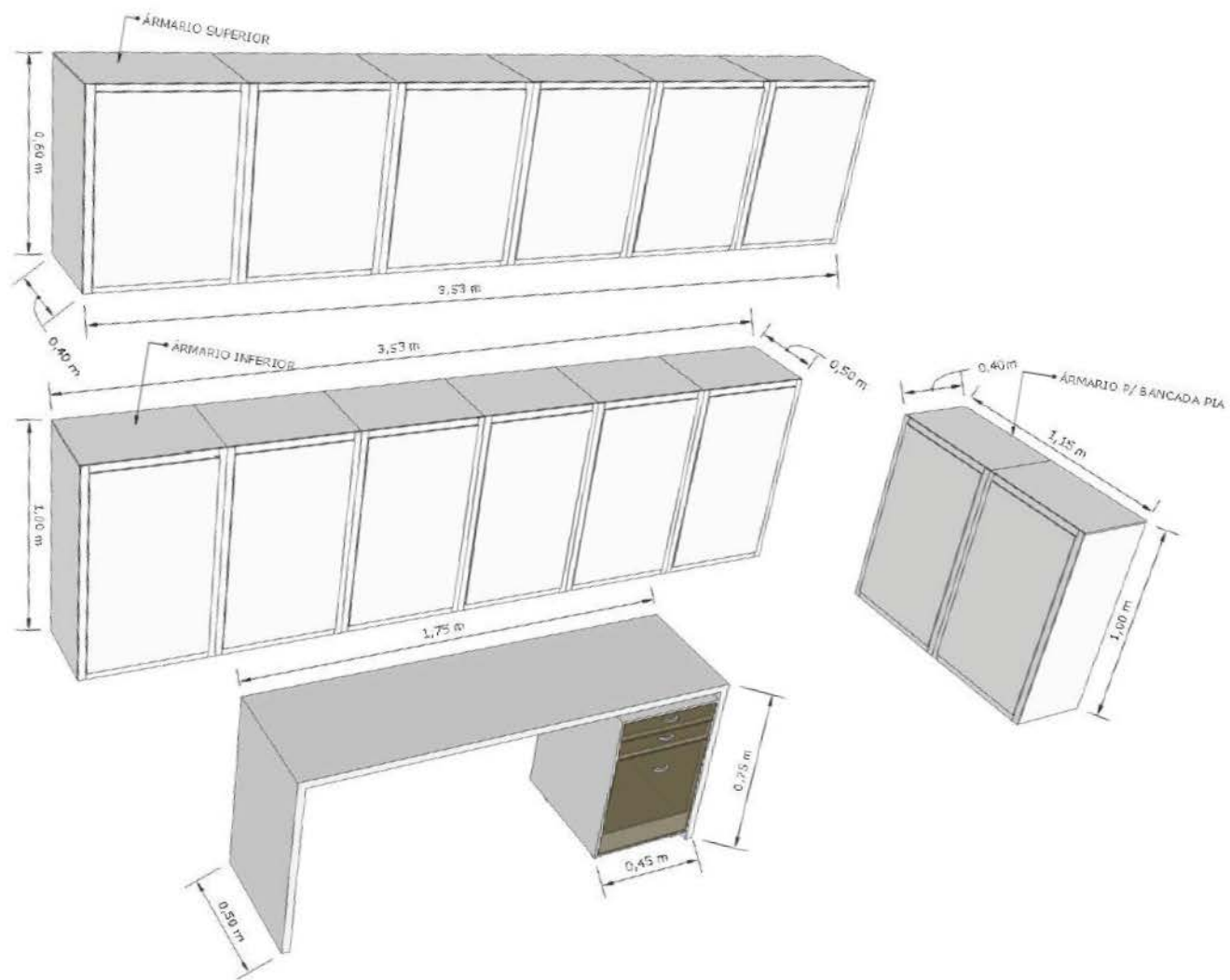

→ SALA DE ESTABILIZAÇÃO

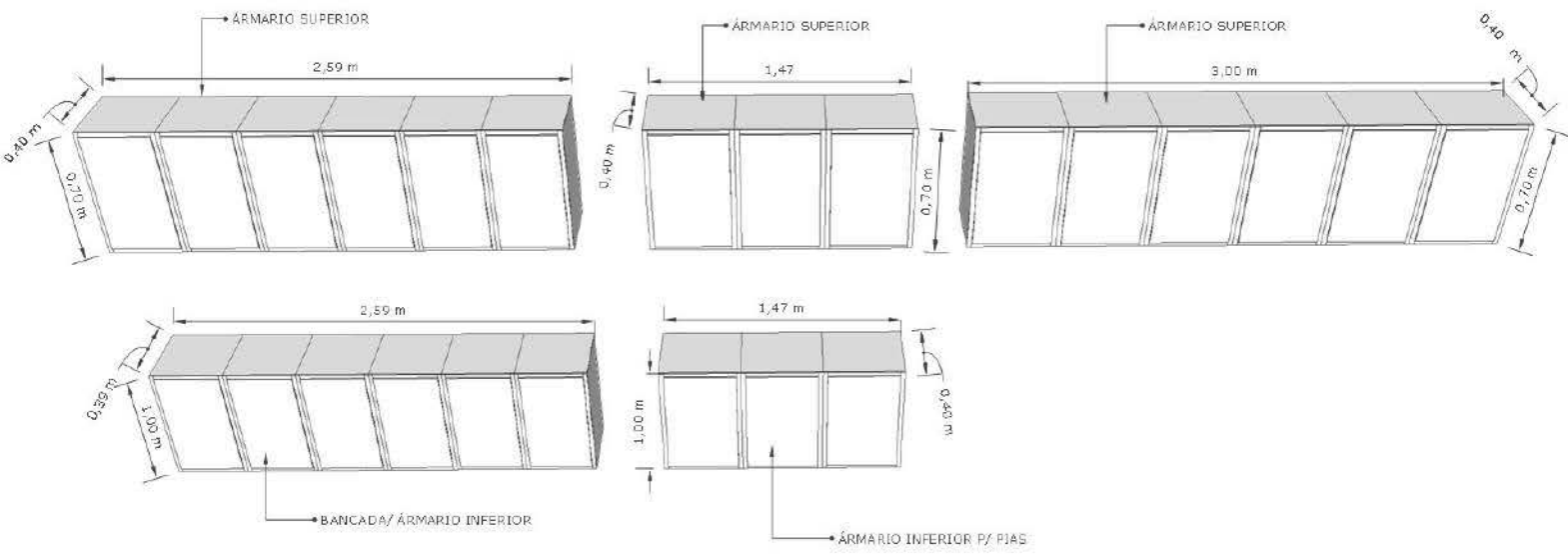

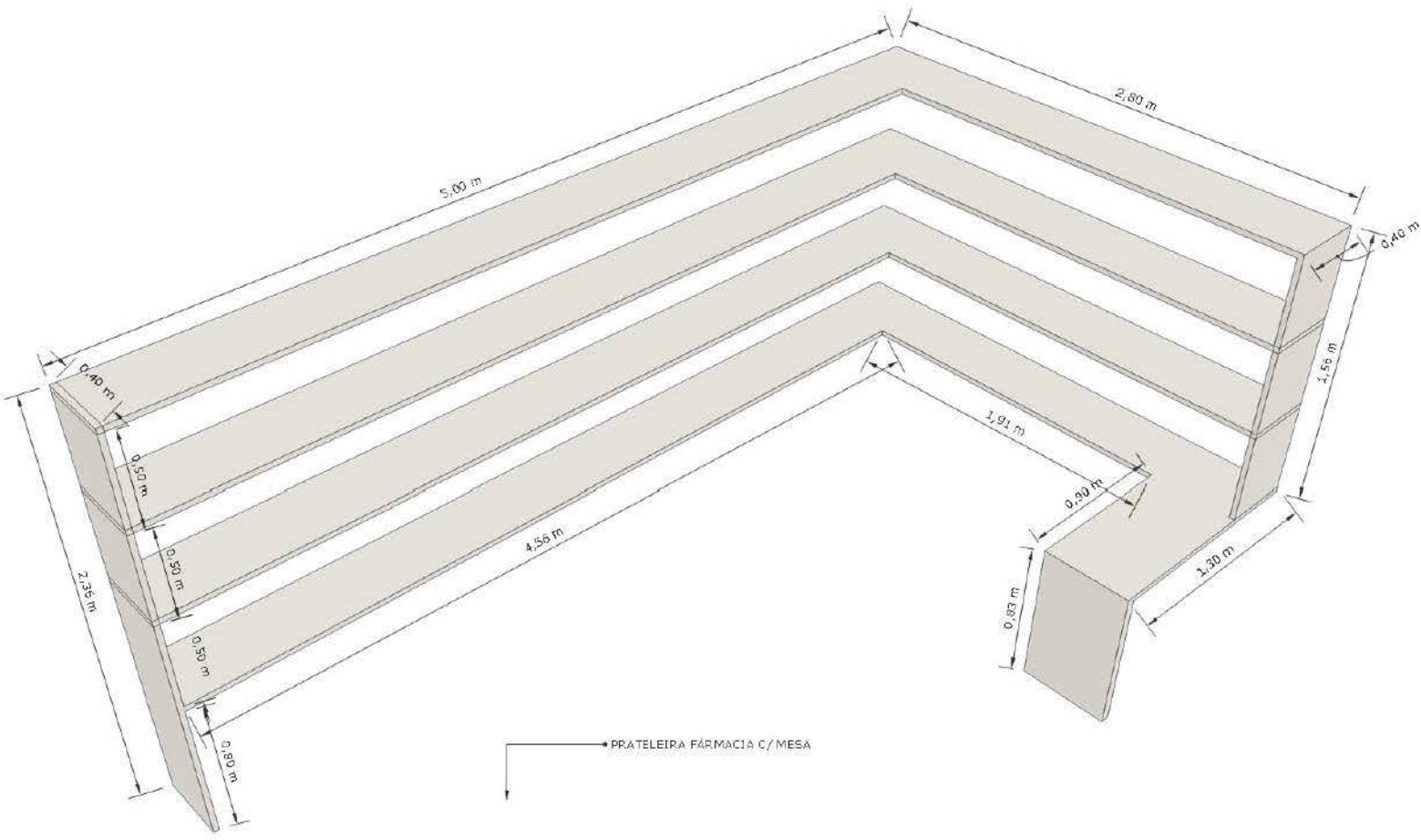

PRATELEIRA FARMACIA C/ MESA

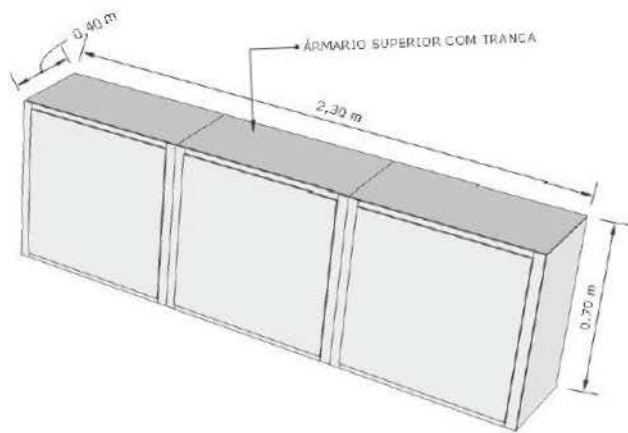
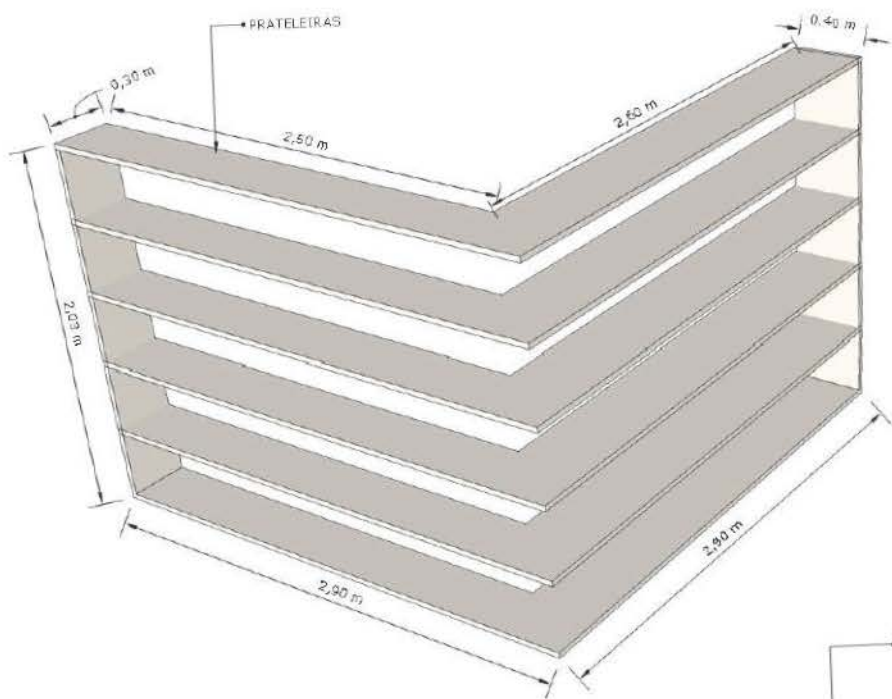

FARMACIA

A label "FARMACIA" with an arrow pointing to the right.



HMSR

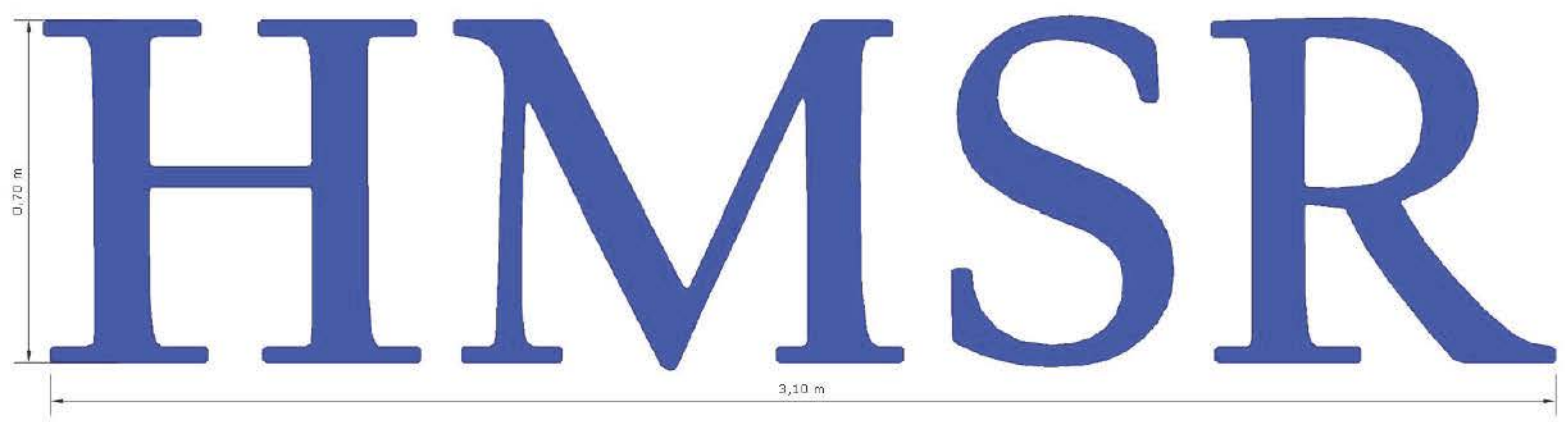

0,70 m

3,10 m

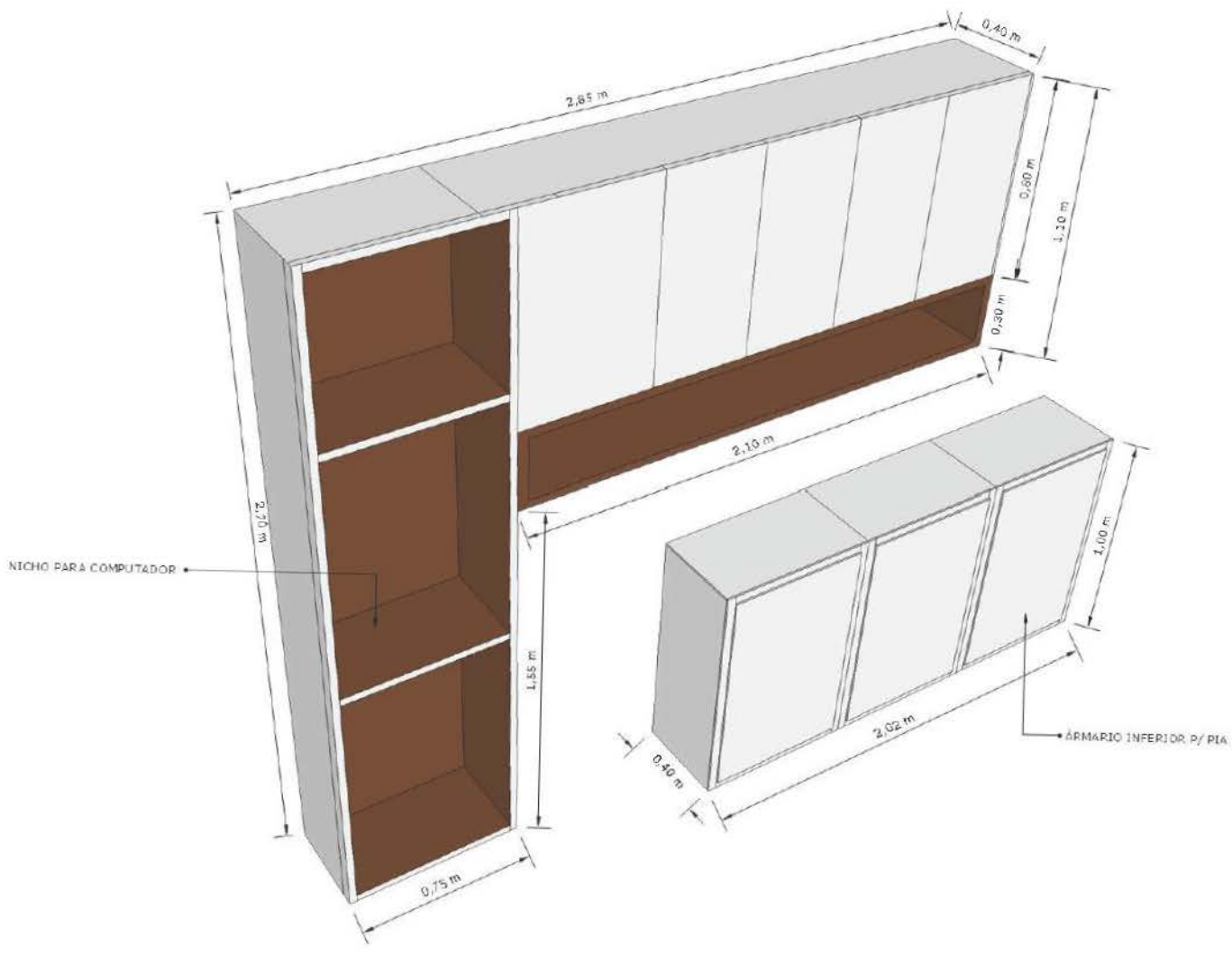

ÁRMARIOS SUPERIORES

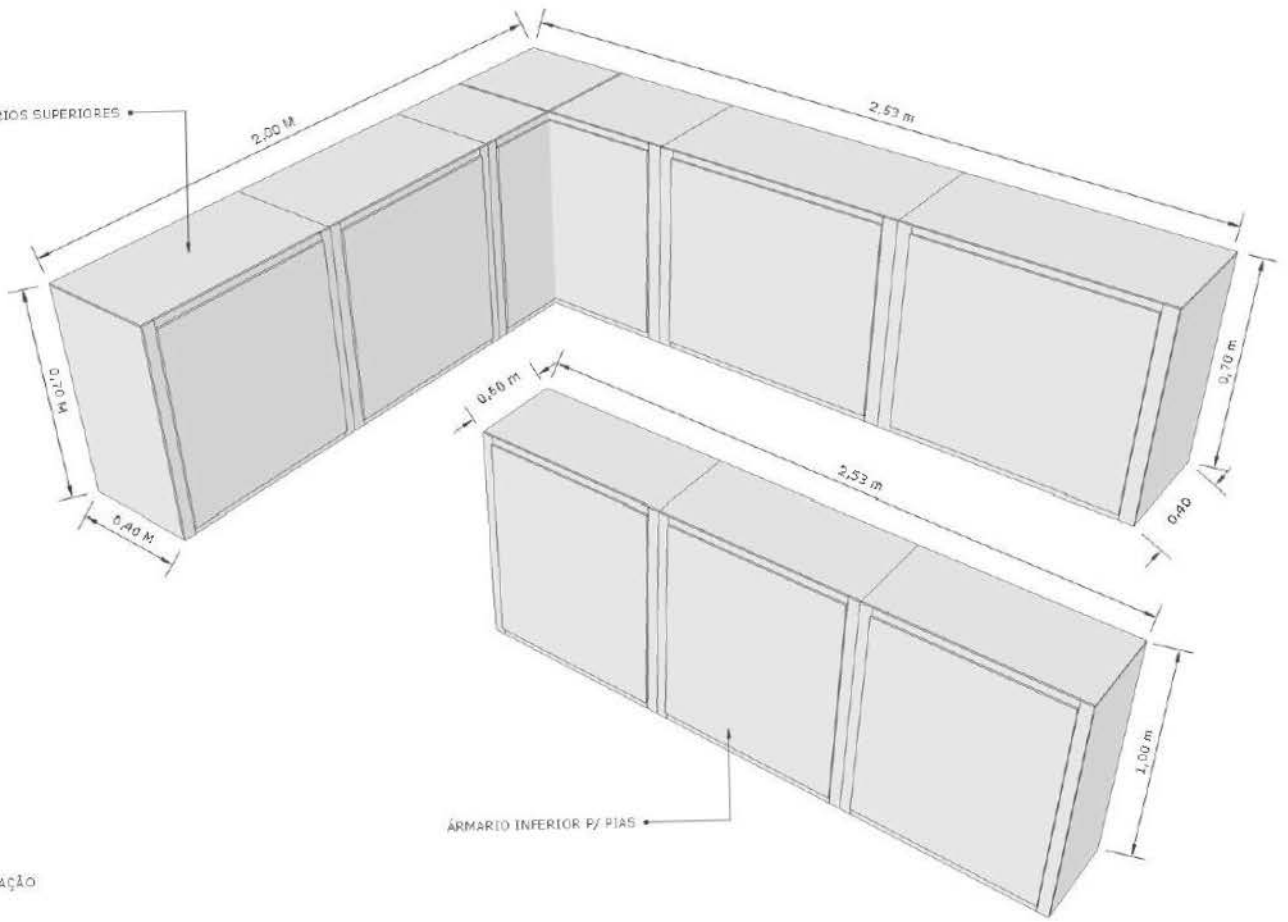

ÁRMARIO INFERIOR P/ PIAS

NEBULIZAÇÃO



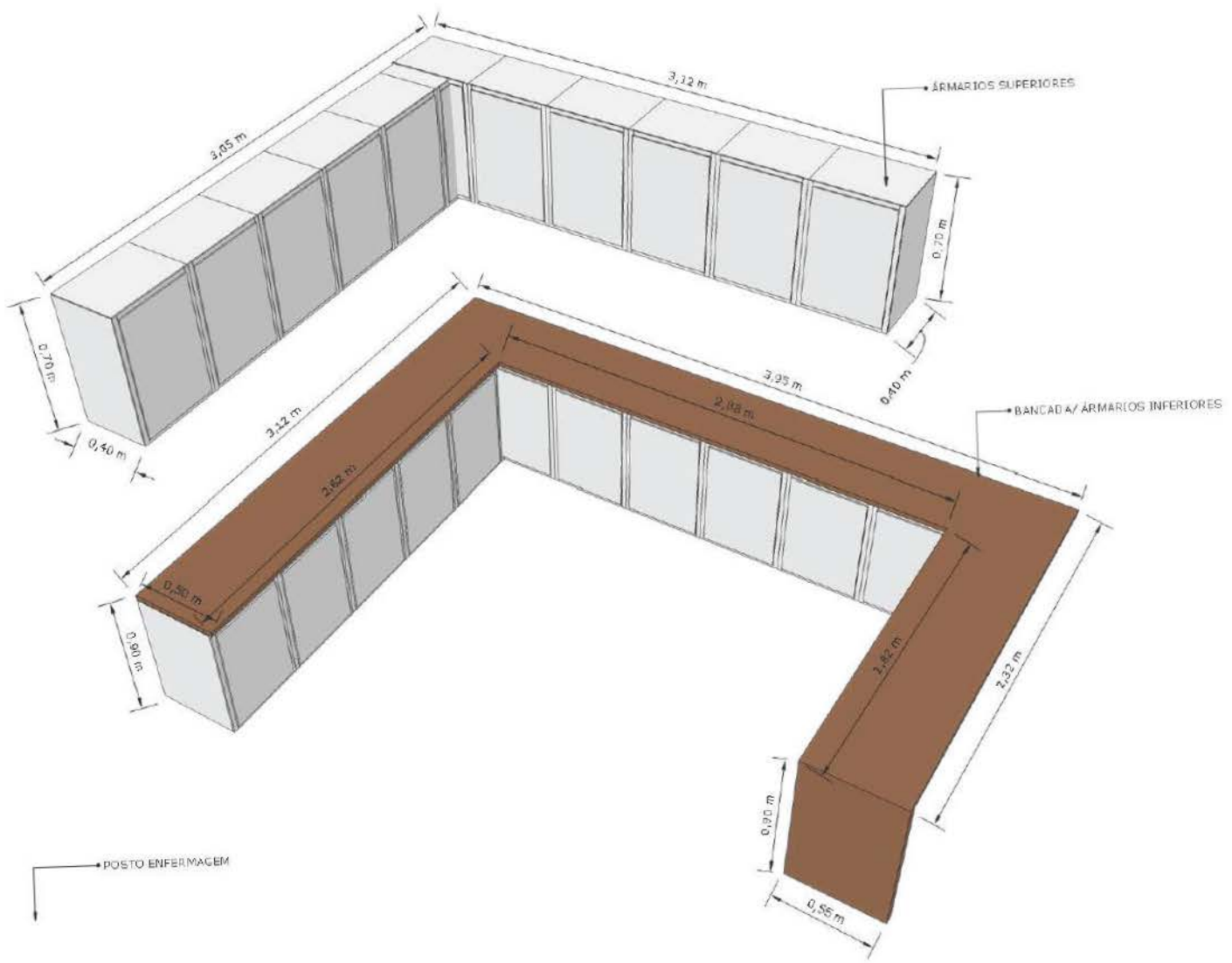

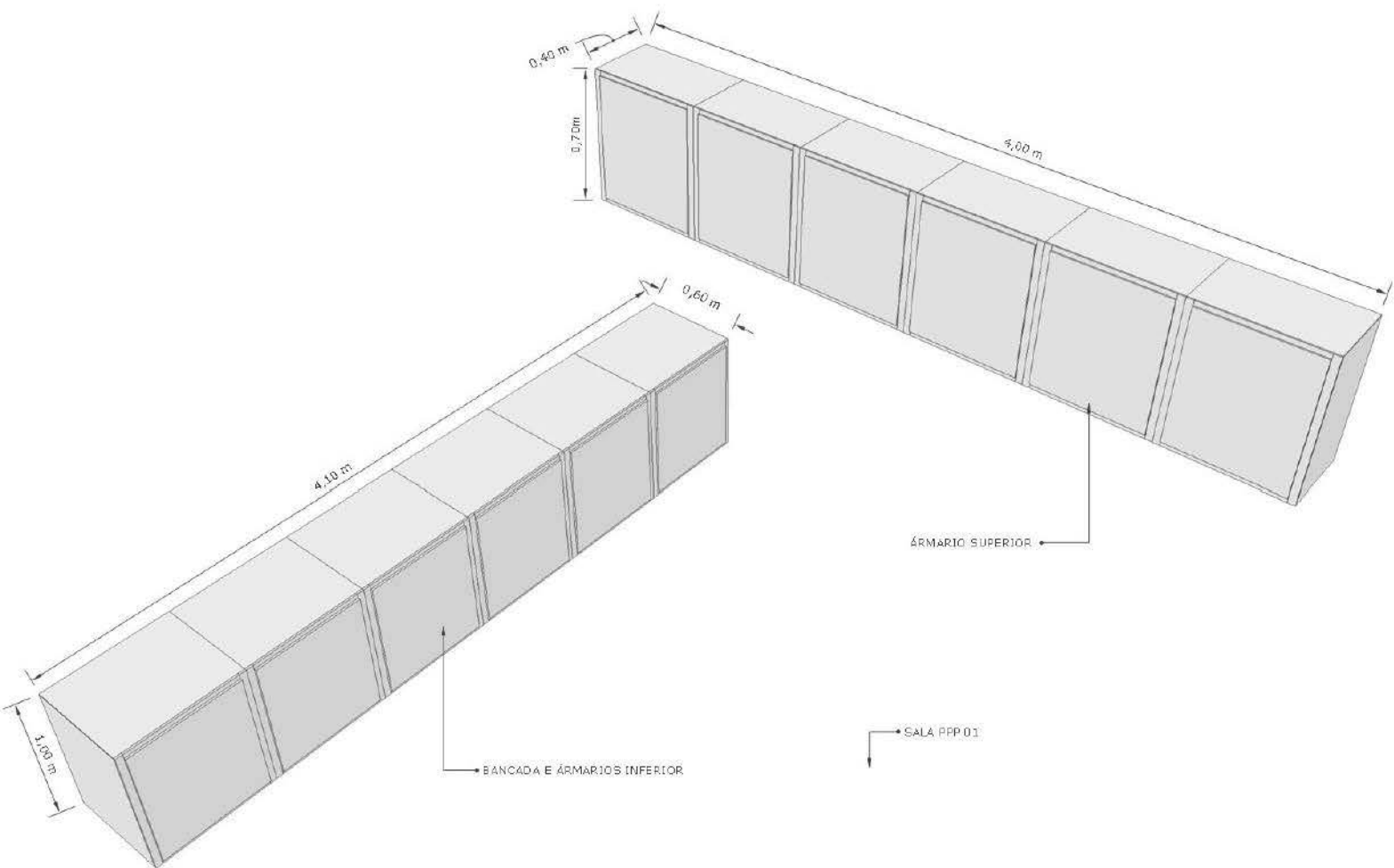

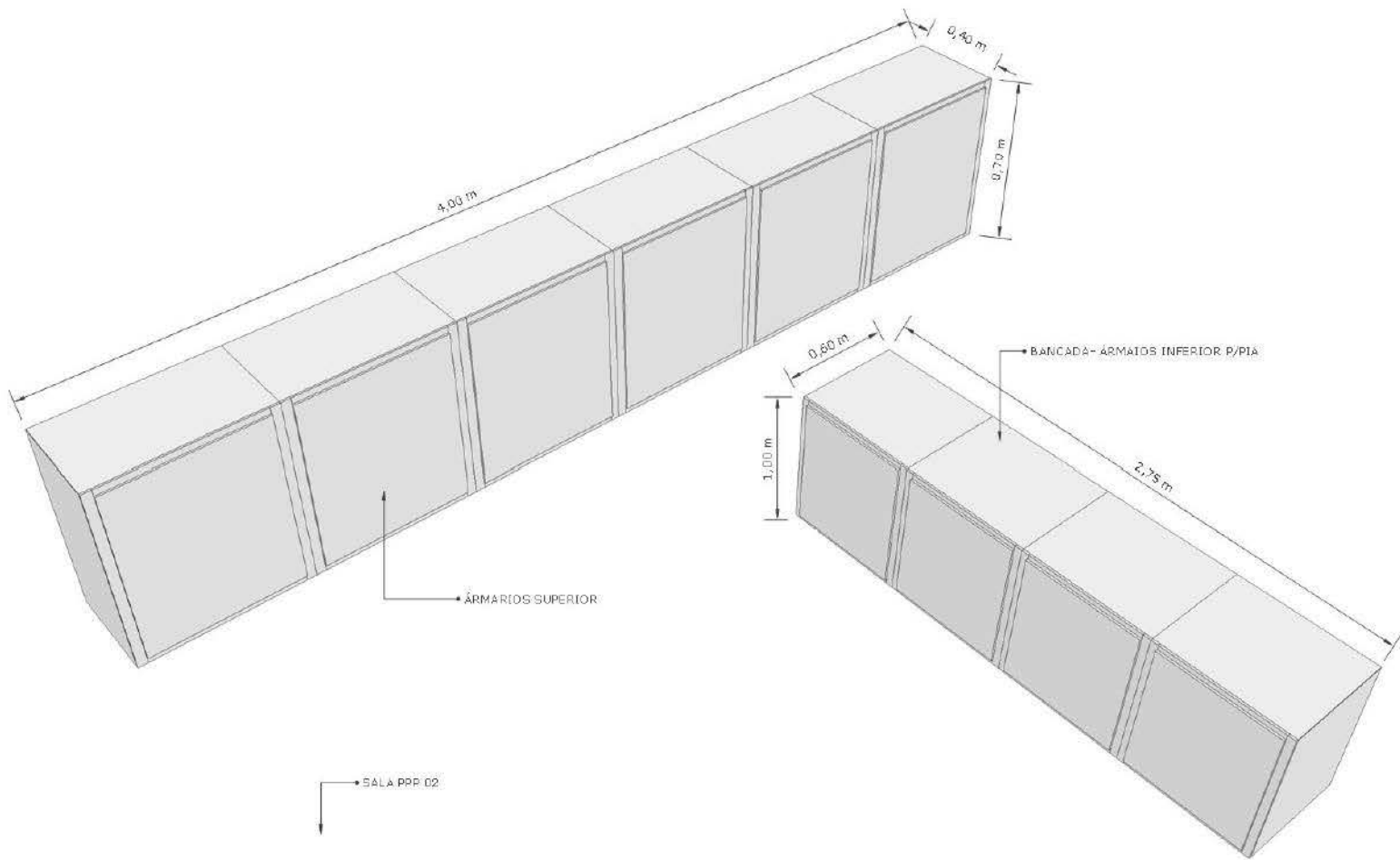

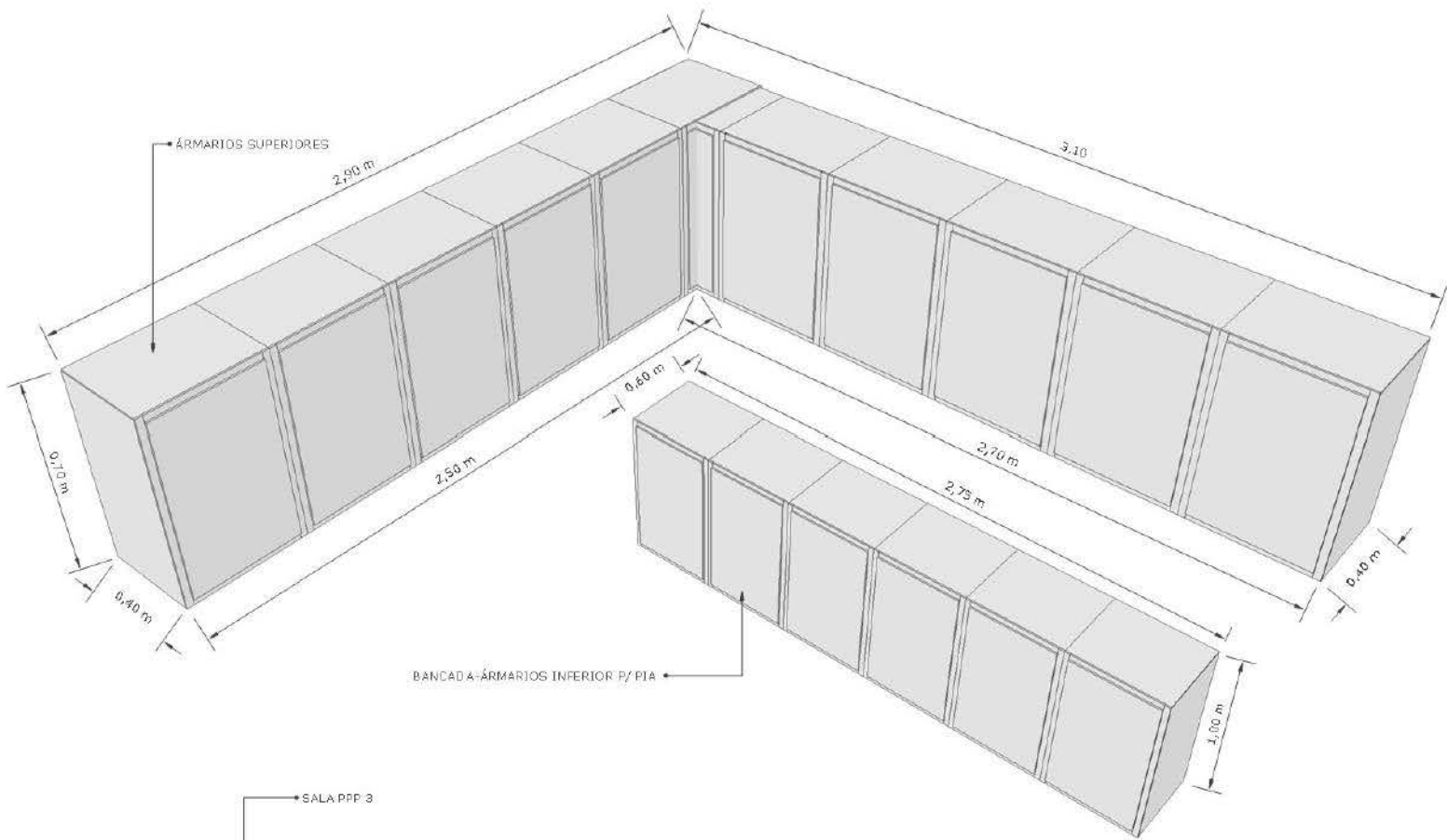

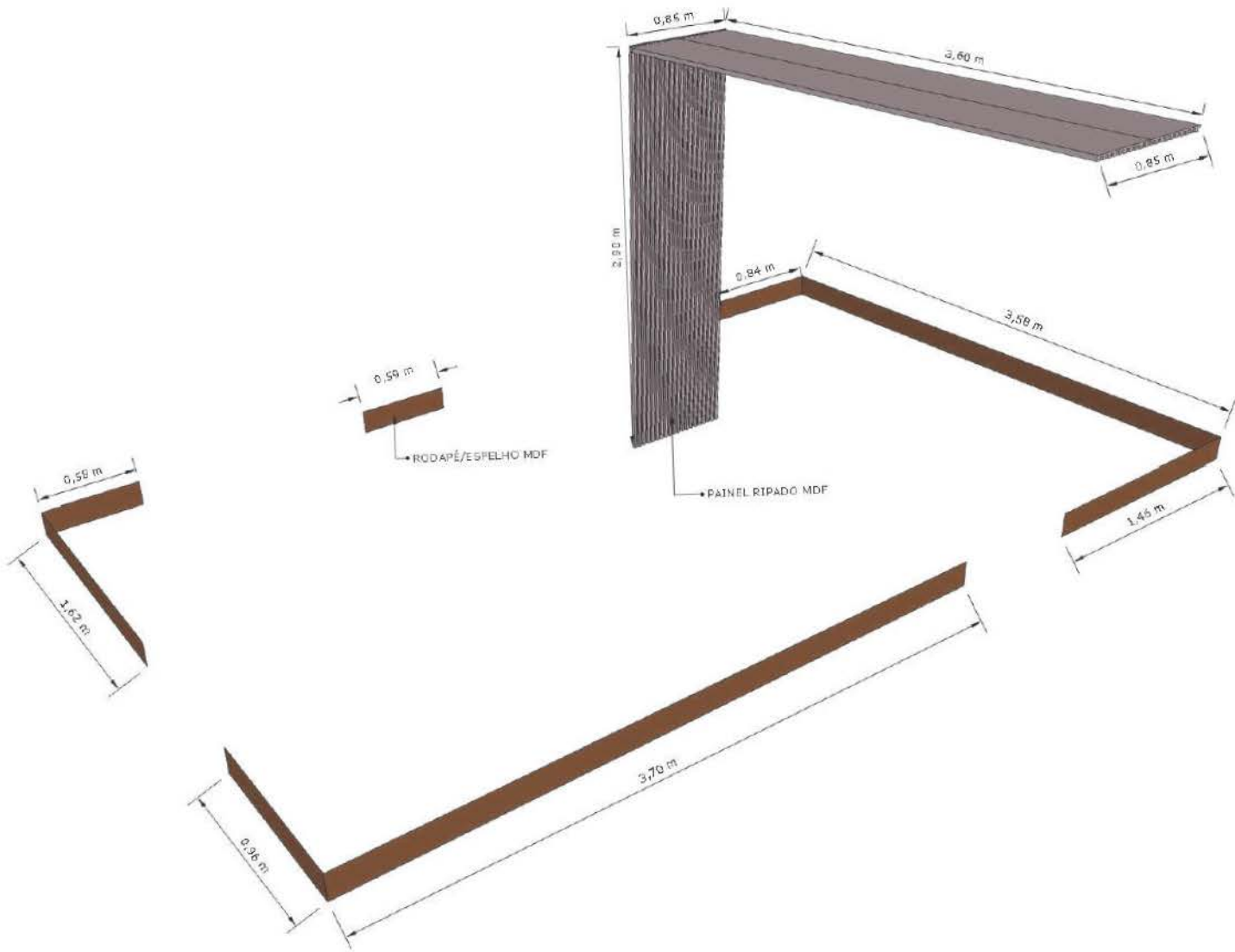



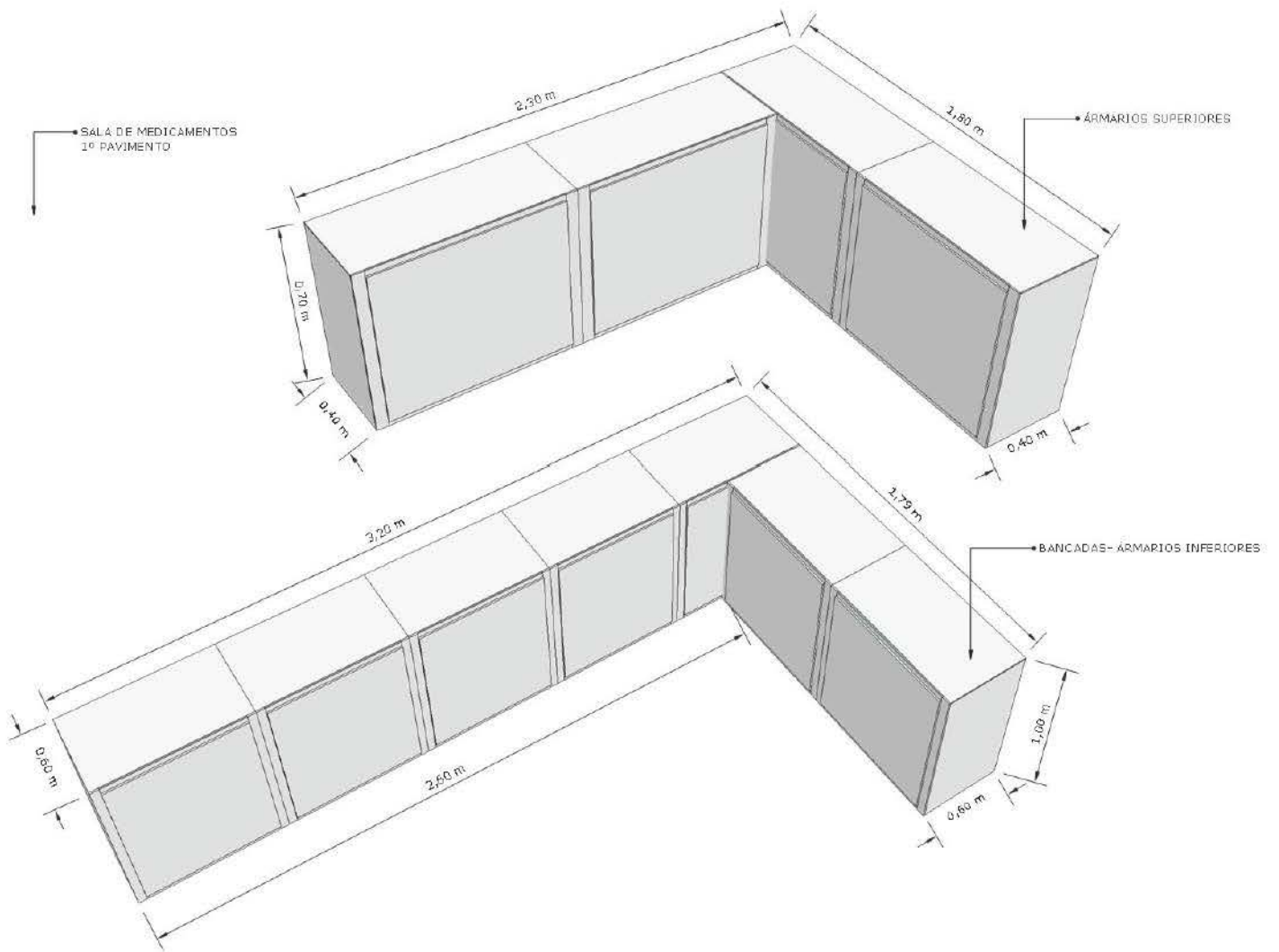

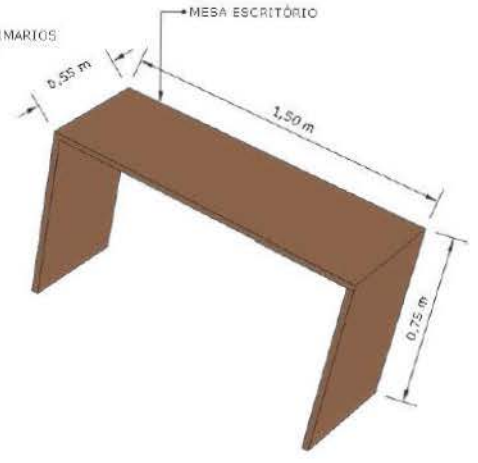
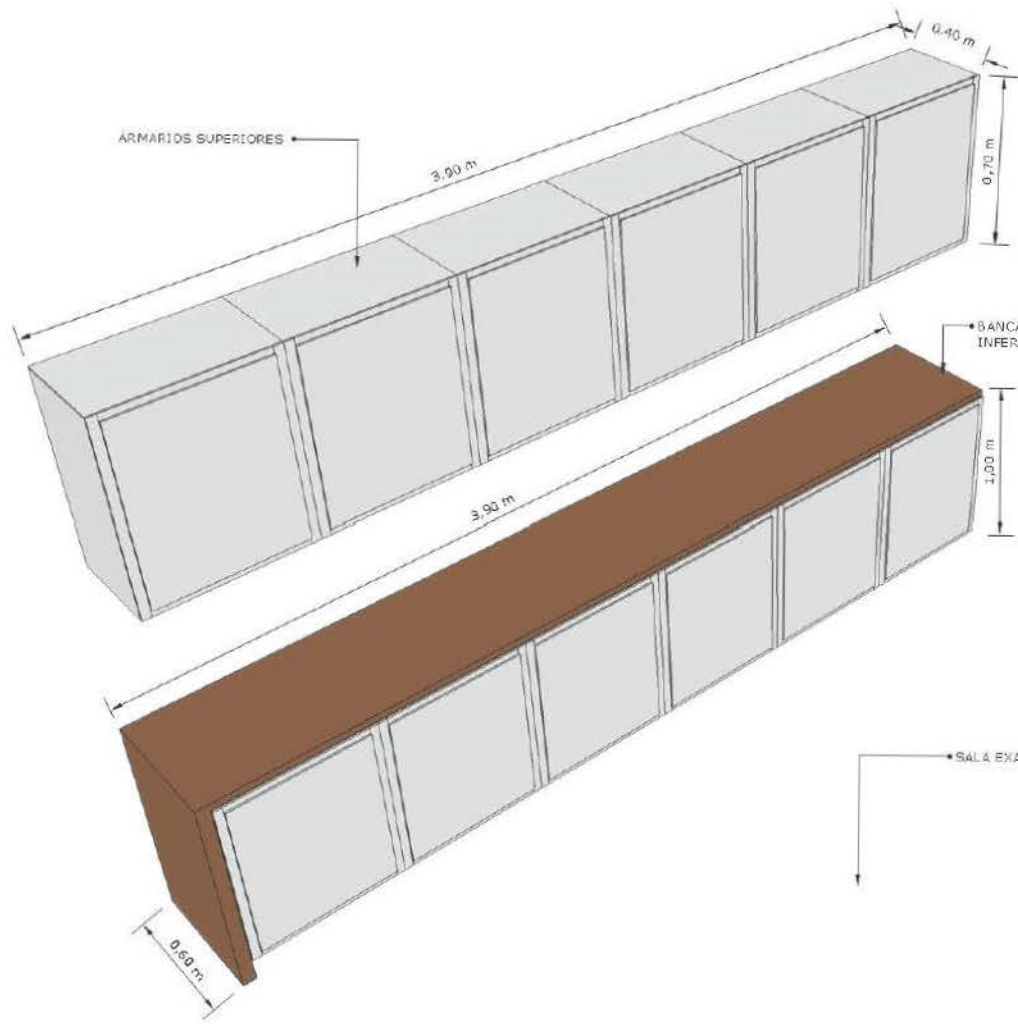

SALA EXAMES

This label points to the area where the cabinet and desk are located.

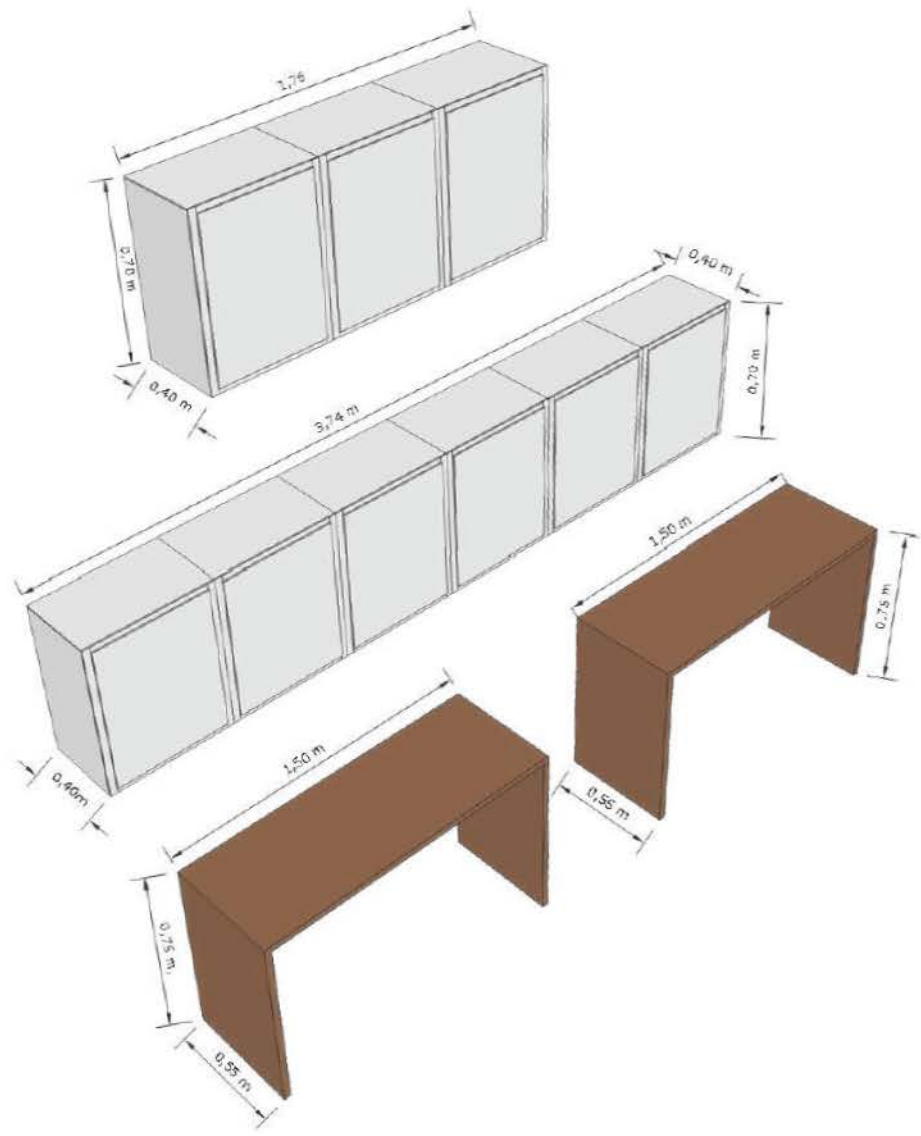

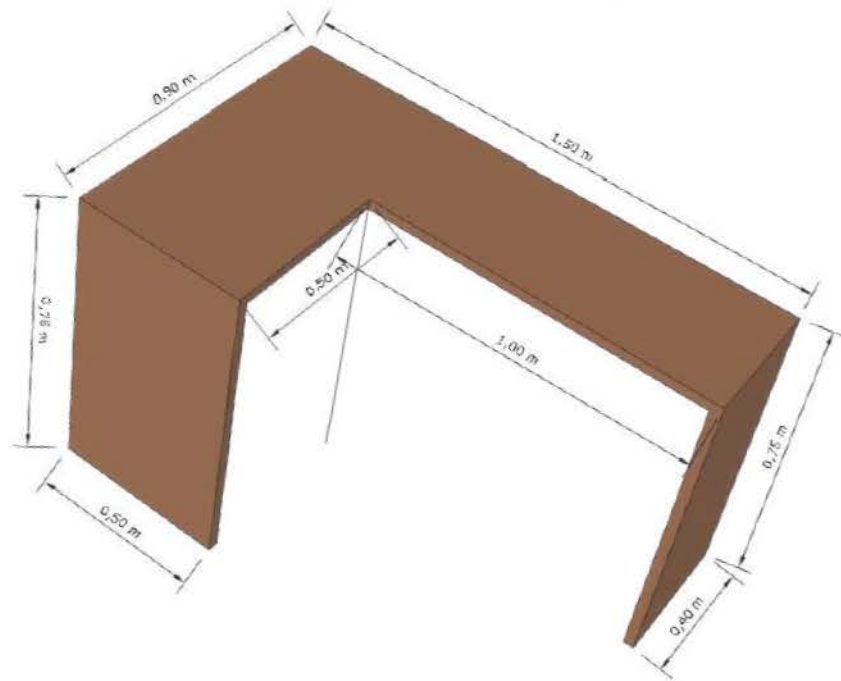
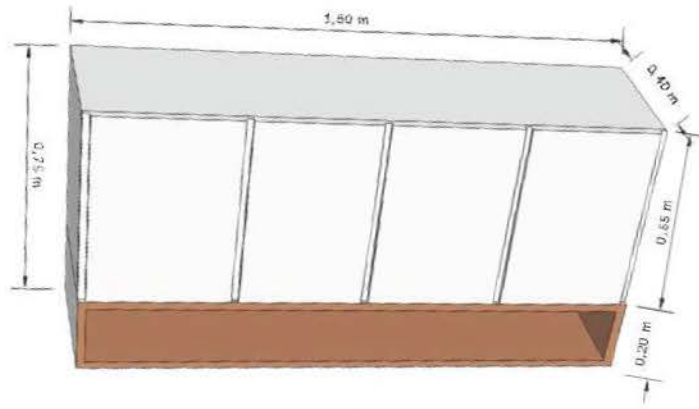

SERVIÇO SOCIAL

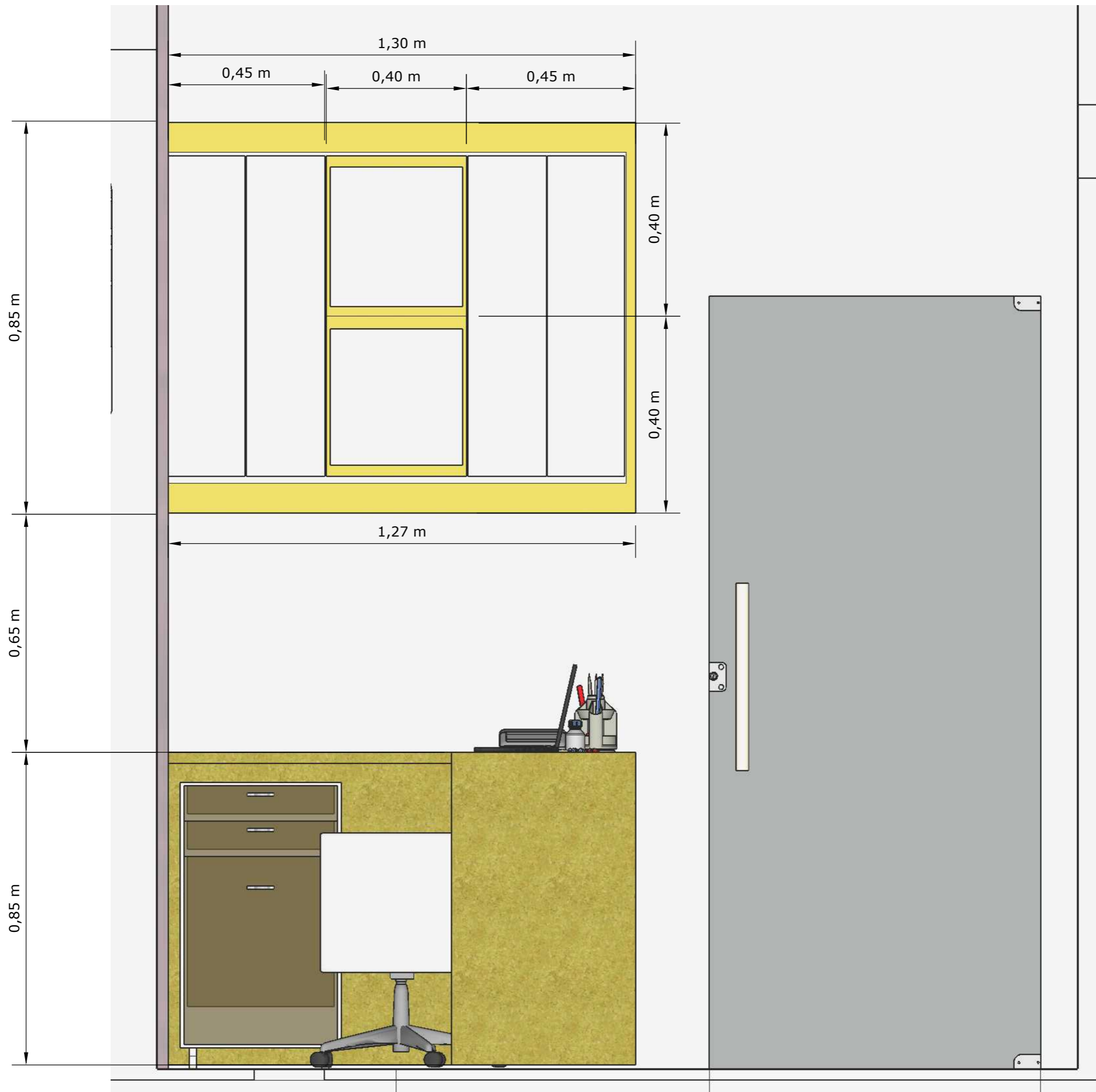

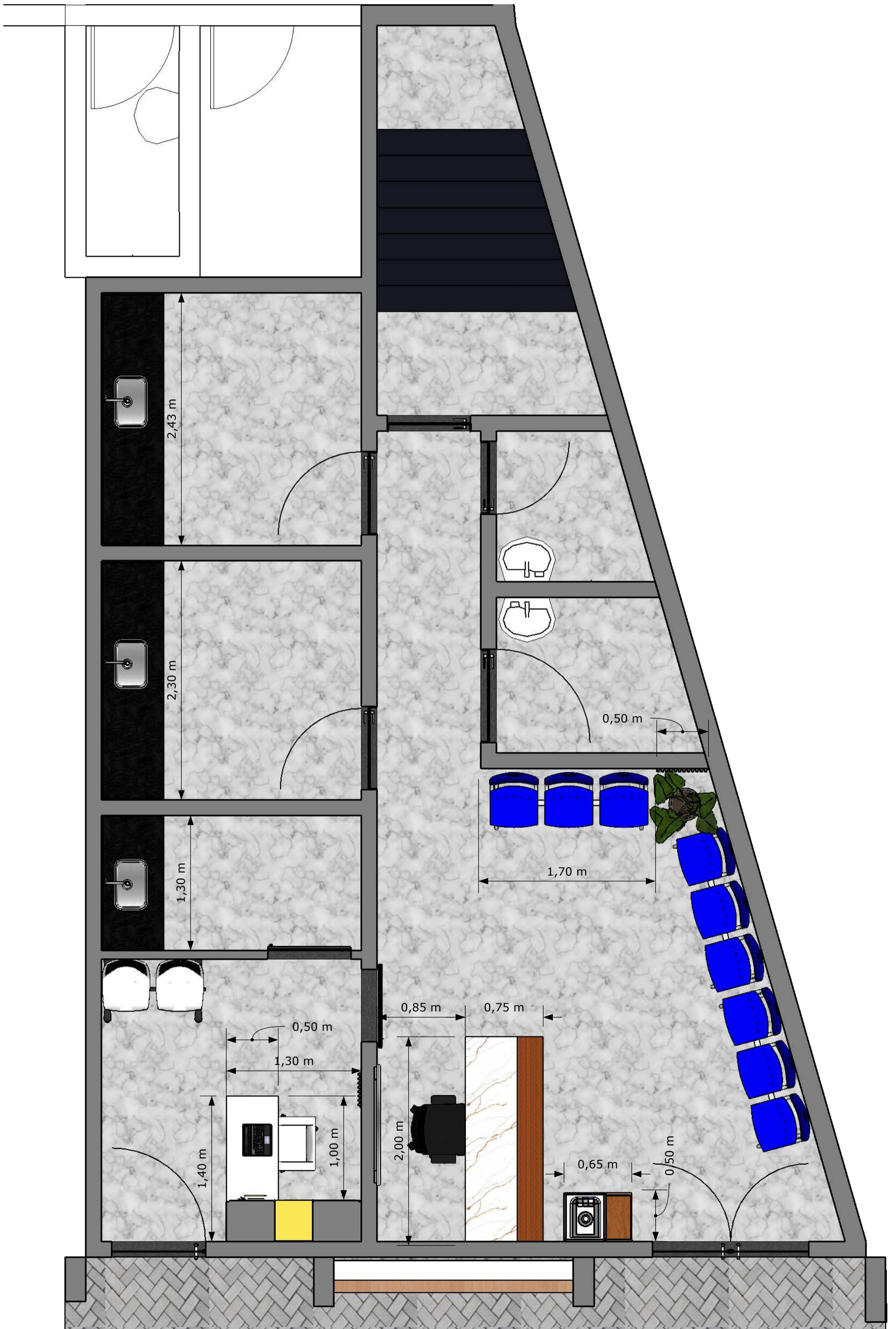

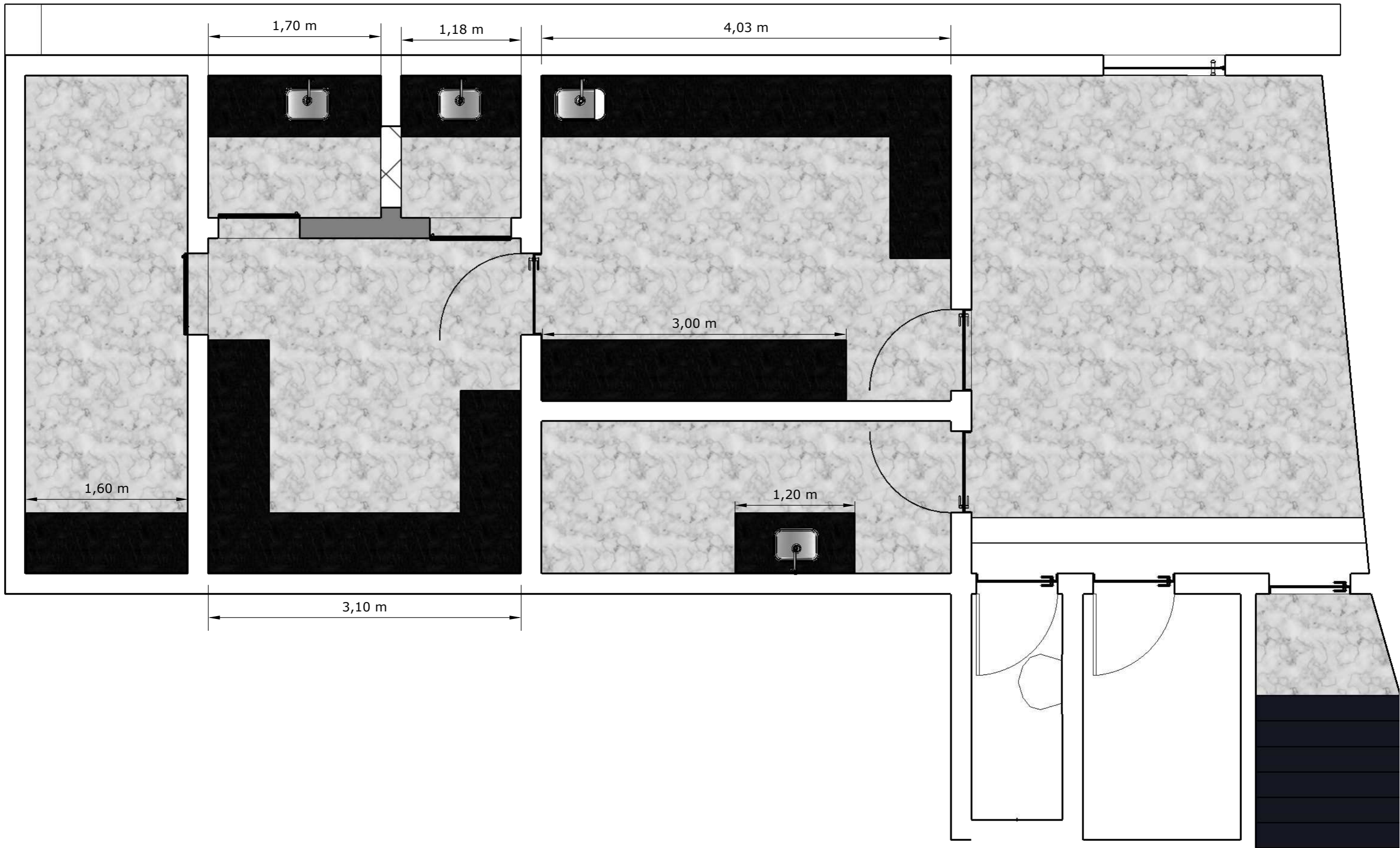

2,70 m

1,30 m

3,89 m

2,30 m

2,43 m

0,60 m

0,60 m

0,60 m

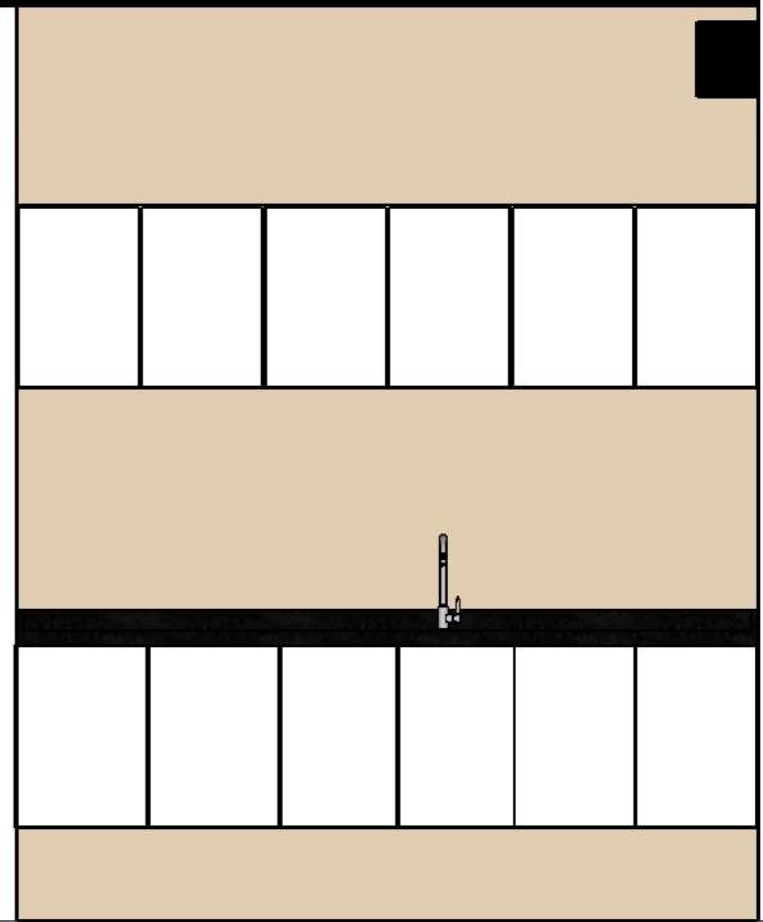
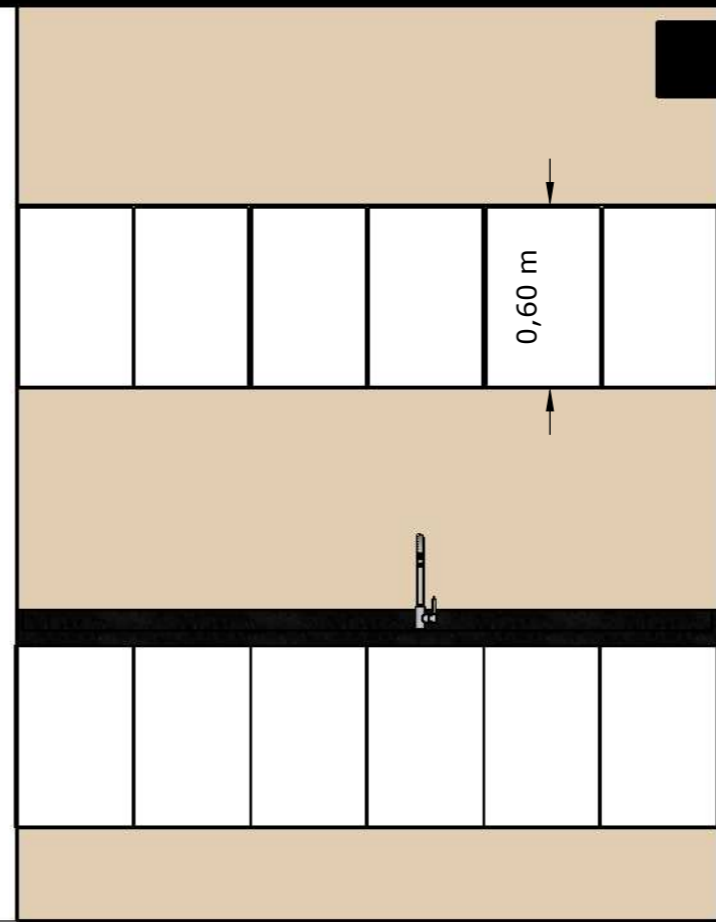
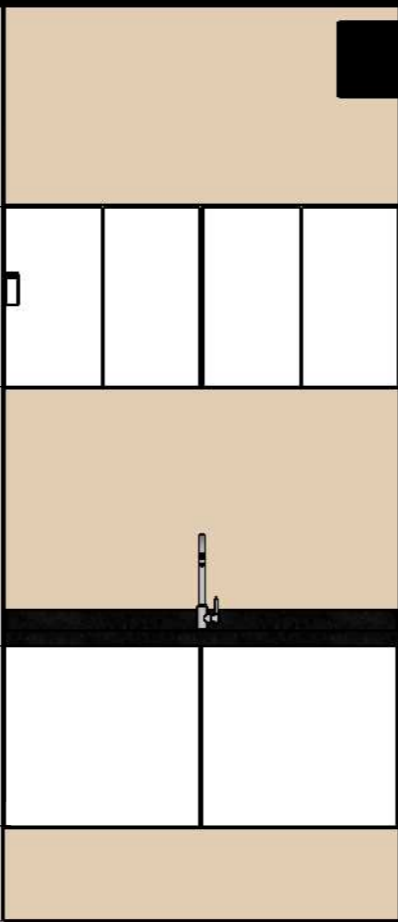
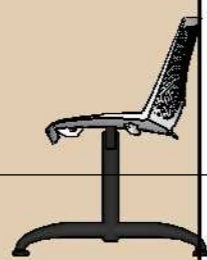



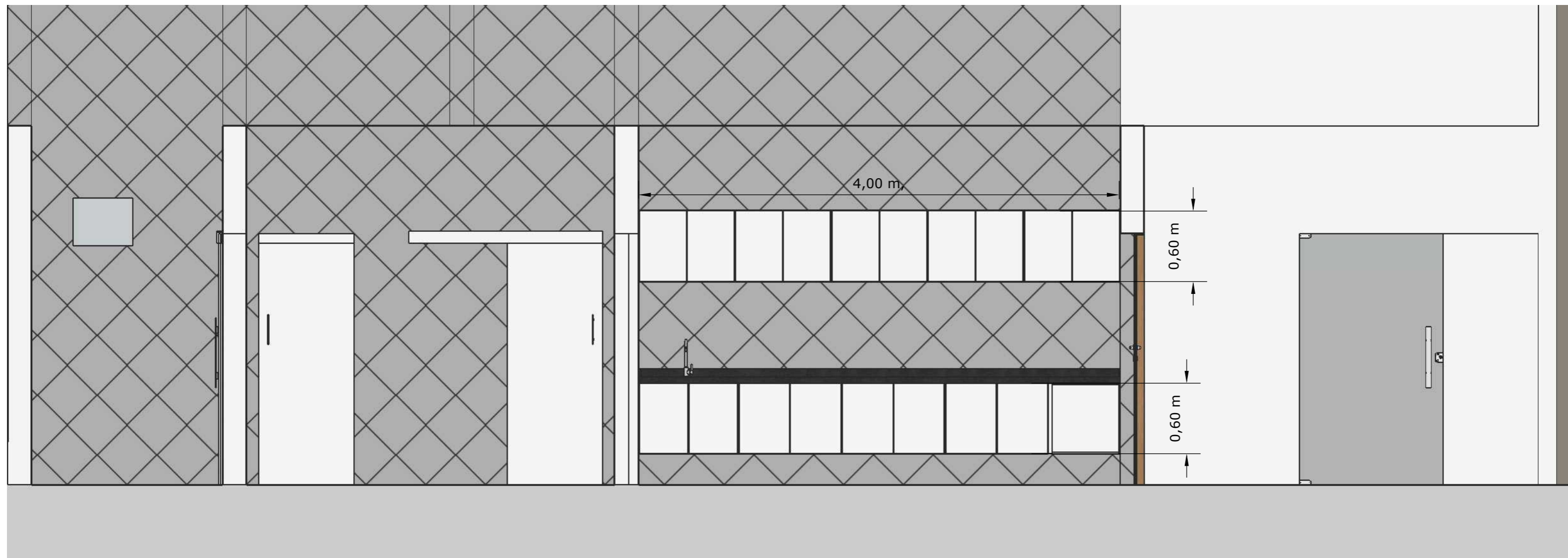

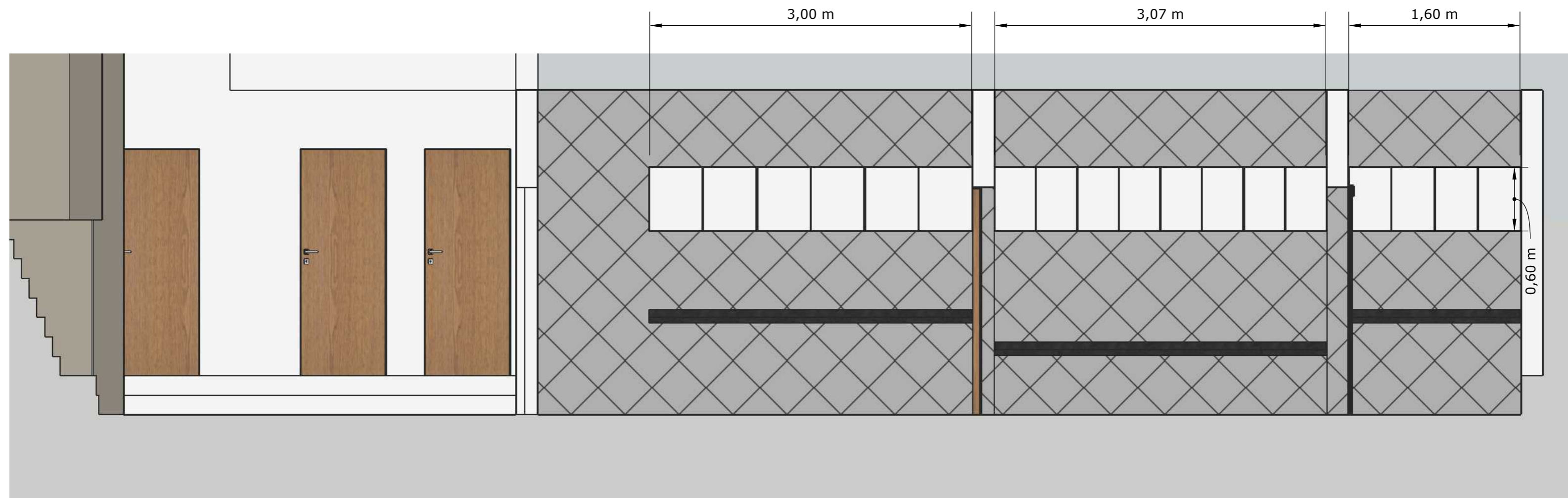

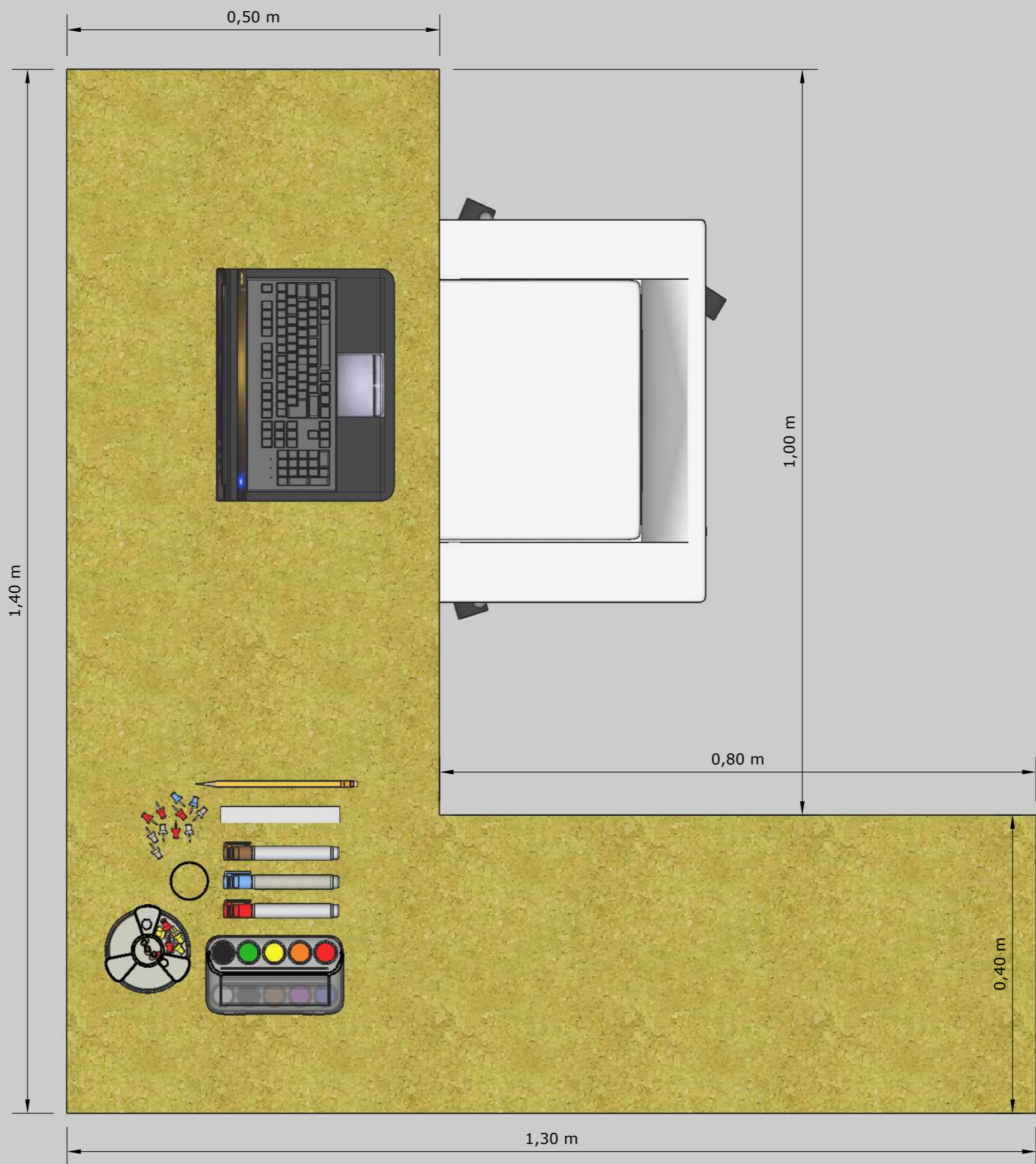

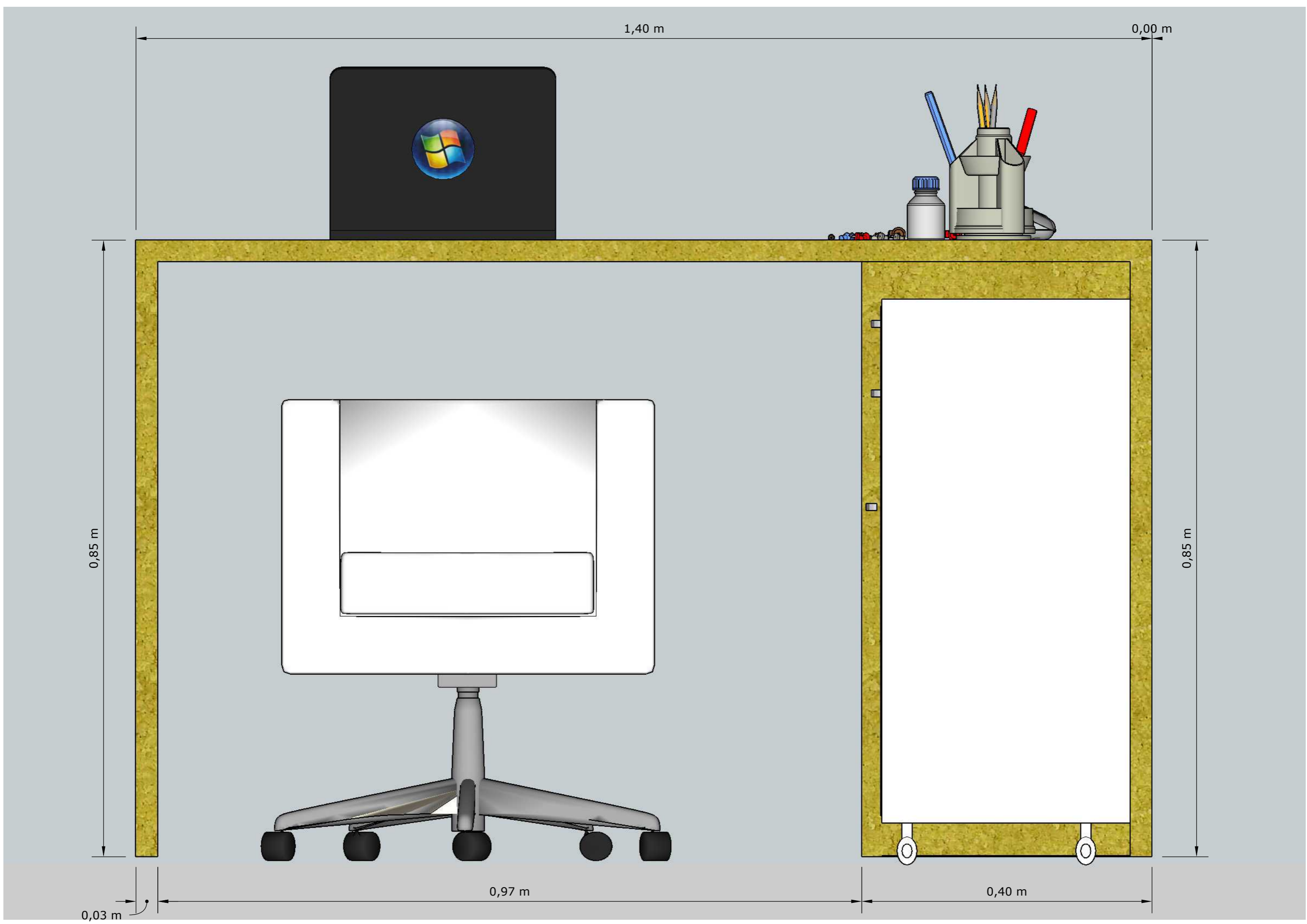

1,40 m

0,00 m

0,85 m

0,85 m

0,03 m

0,97 m

0,40 m

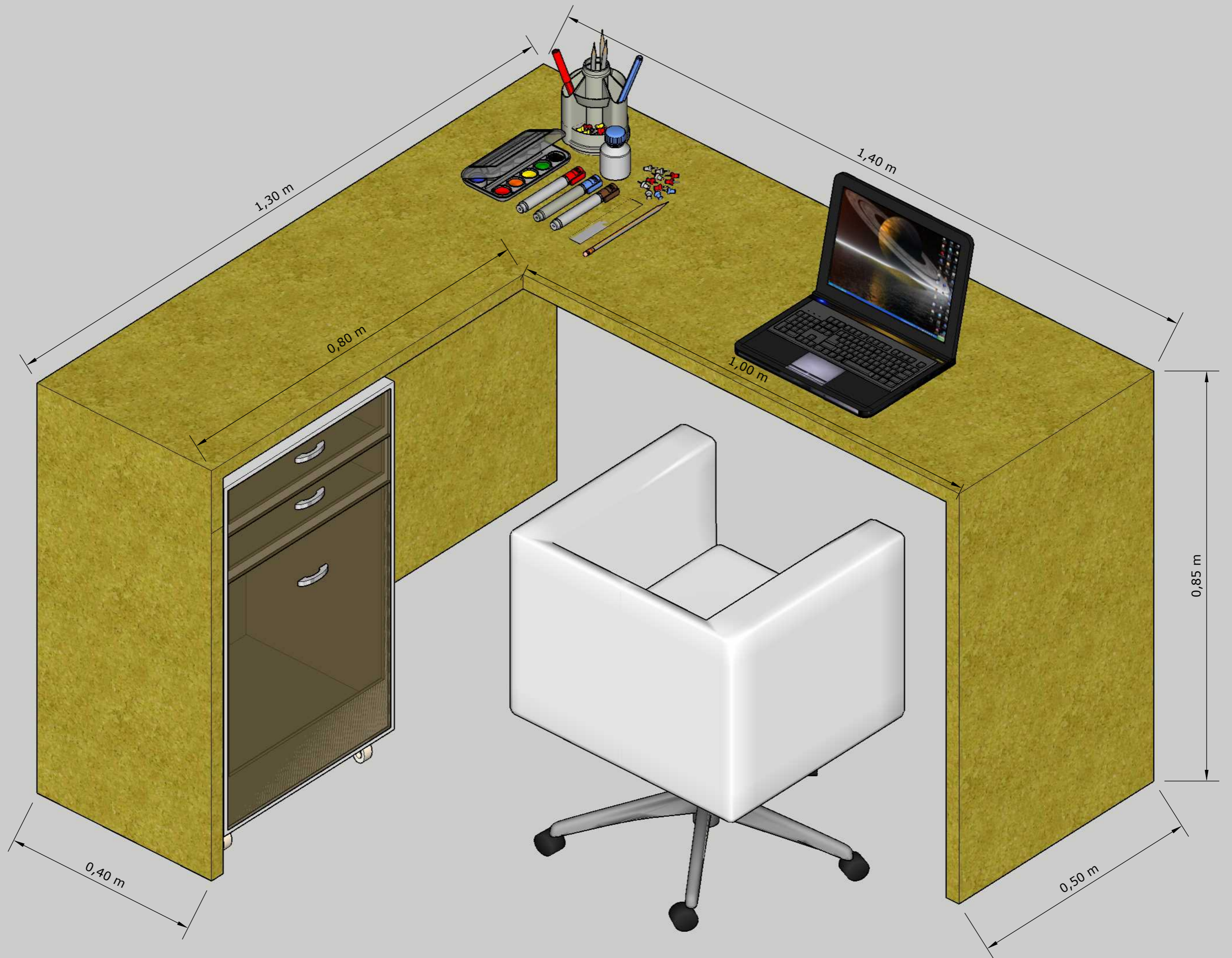



2,81 m

0,40 m

1,20 m

1,91 m

1,75 m

0,85 m

0,50 m

3,50 m

0,40 m

1,60 m

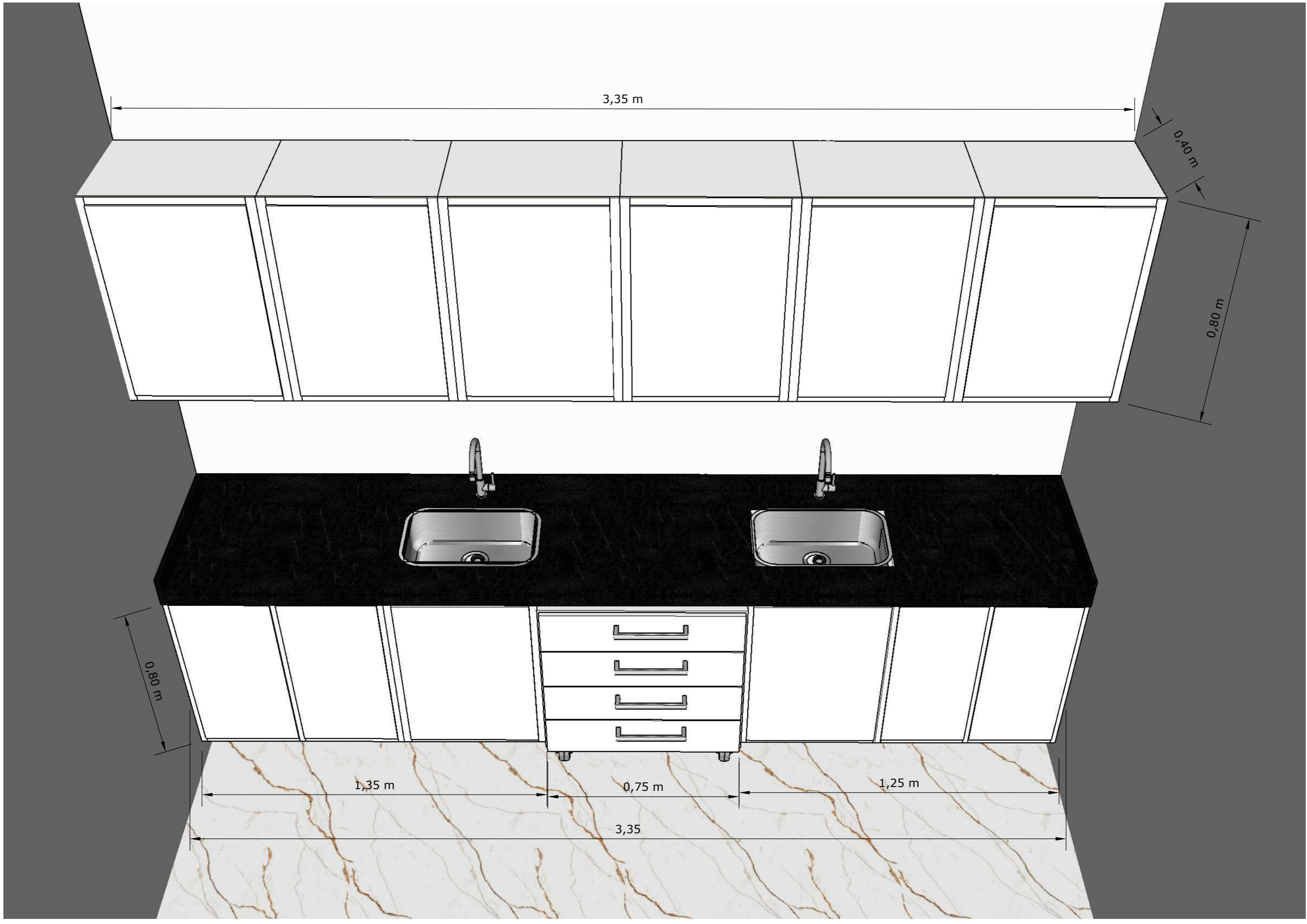

3,35 m

0,40 m

0,80 m

0,80 m

1,35 m

0,75 m

1,25 m

3,35



3,35 m

0,40 m

0,80 m

1,50 m

0,45 m

0,40 m

1,25 m

0,50 m

0,90 m





1,10 m

0,90 m

0,30 m

2,45 m

0,55 m

1,20 m

0,90 m

2,80 m



3,02 m

0,40 m

0,80 m

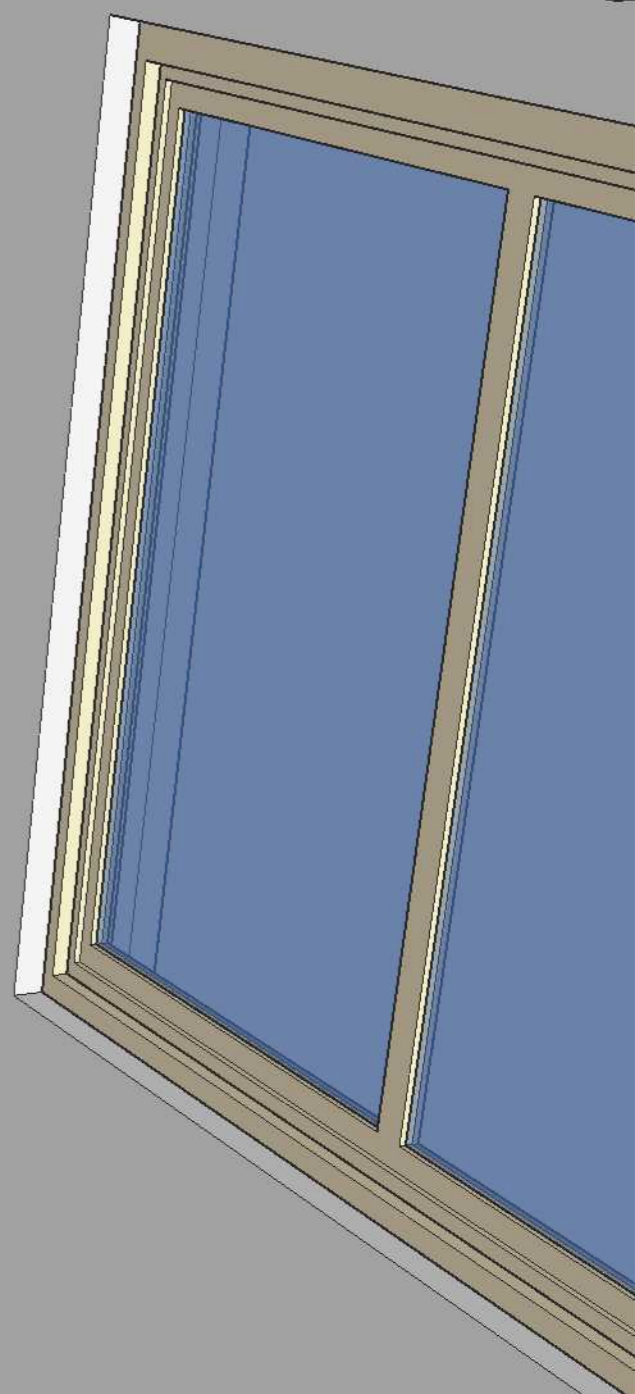
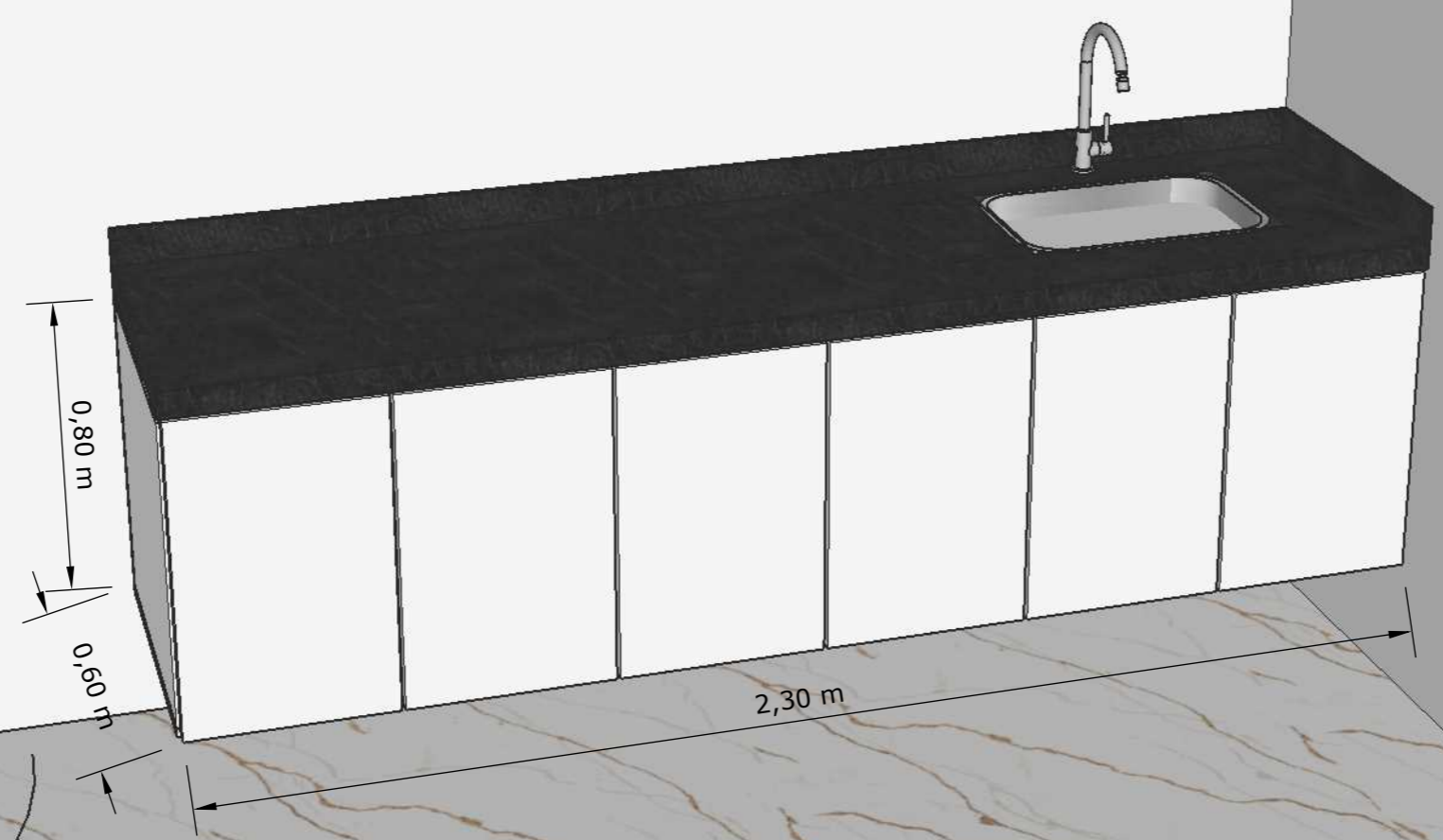
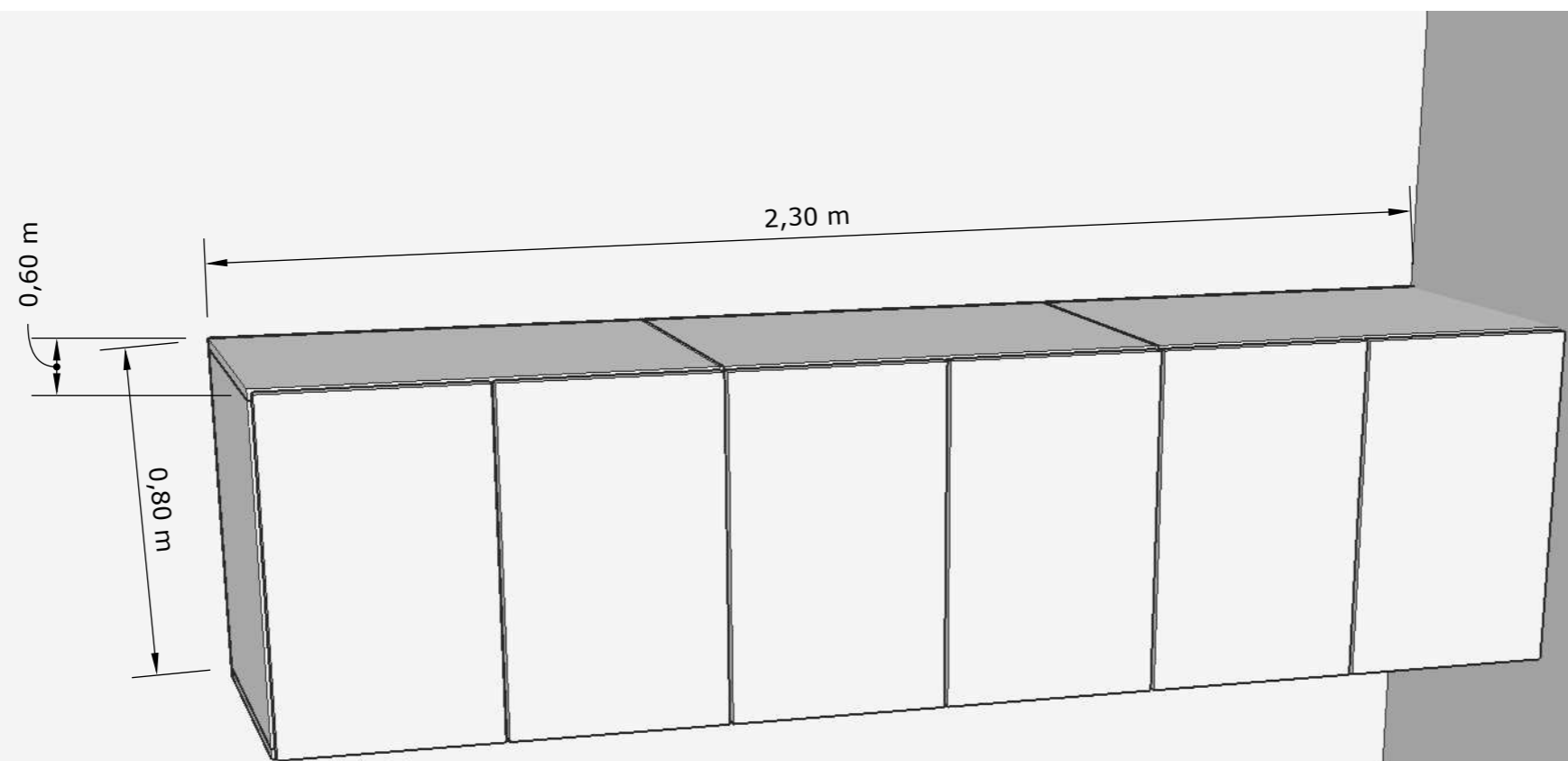



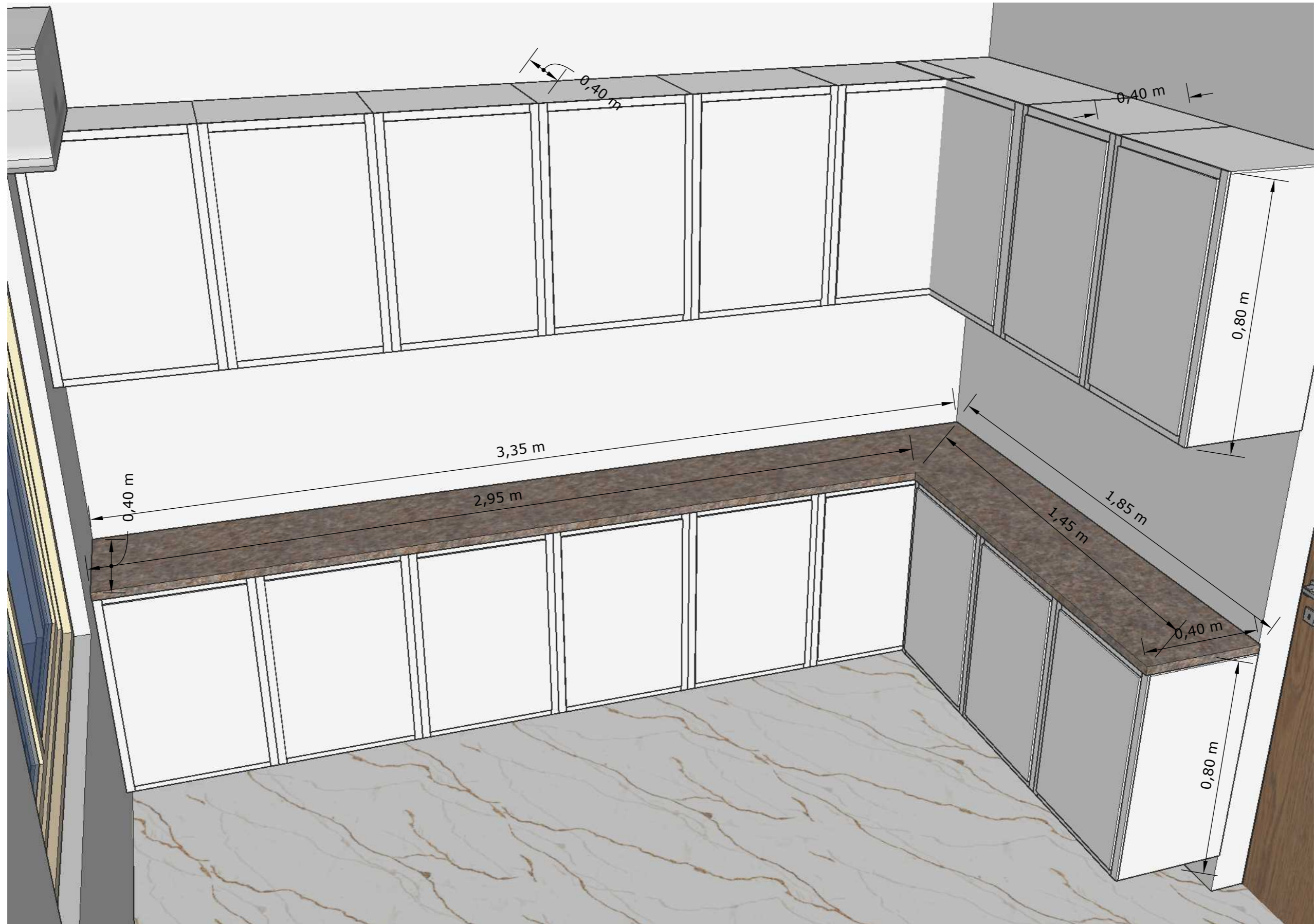



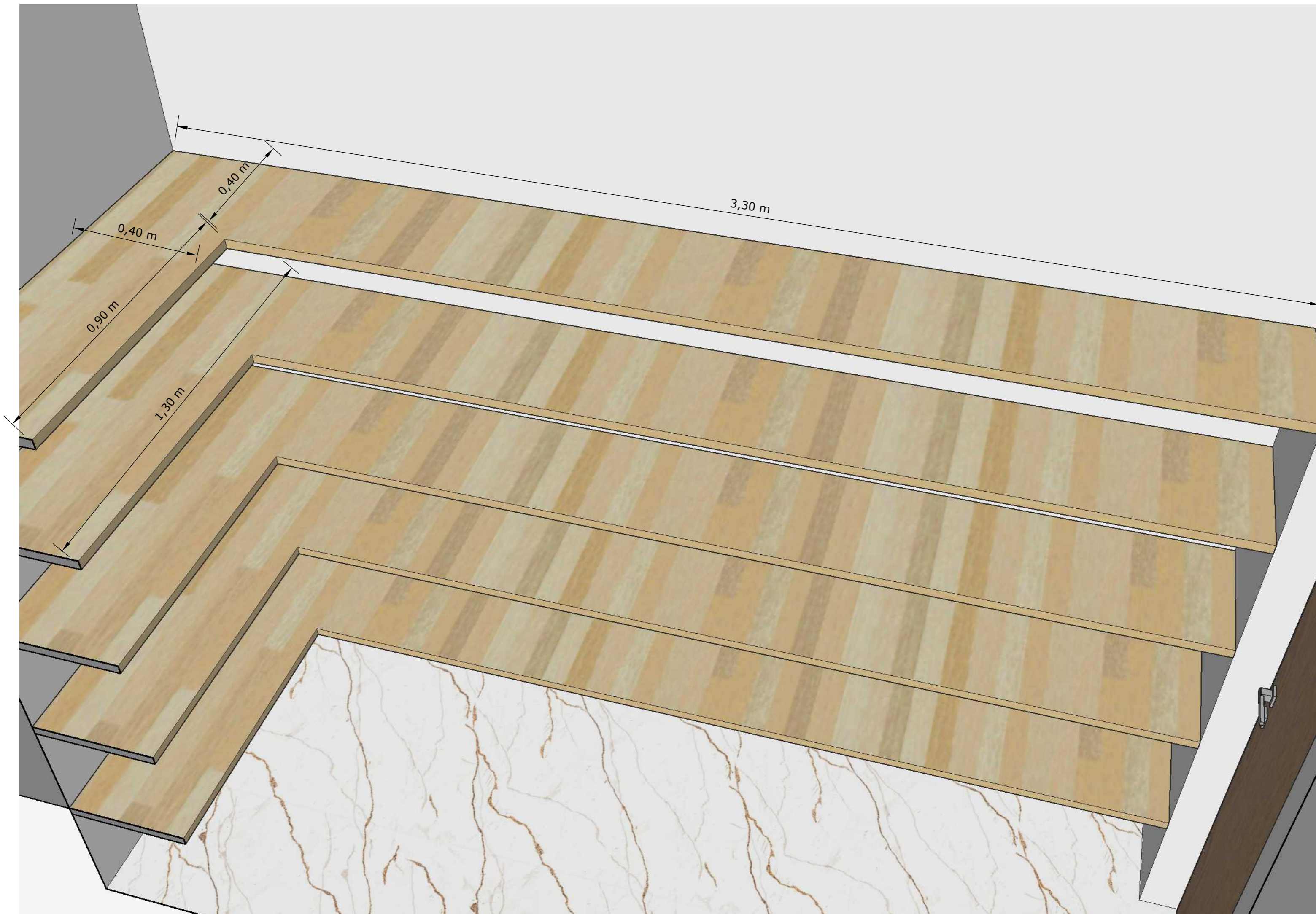



2,81 m

0,40 m

1,20 m

1,91 m

1,75 m

0,85 m

0,50 m

3,50 m

0,40 m

1,60 m



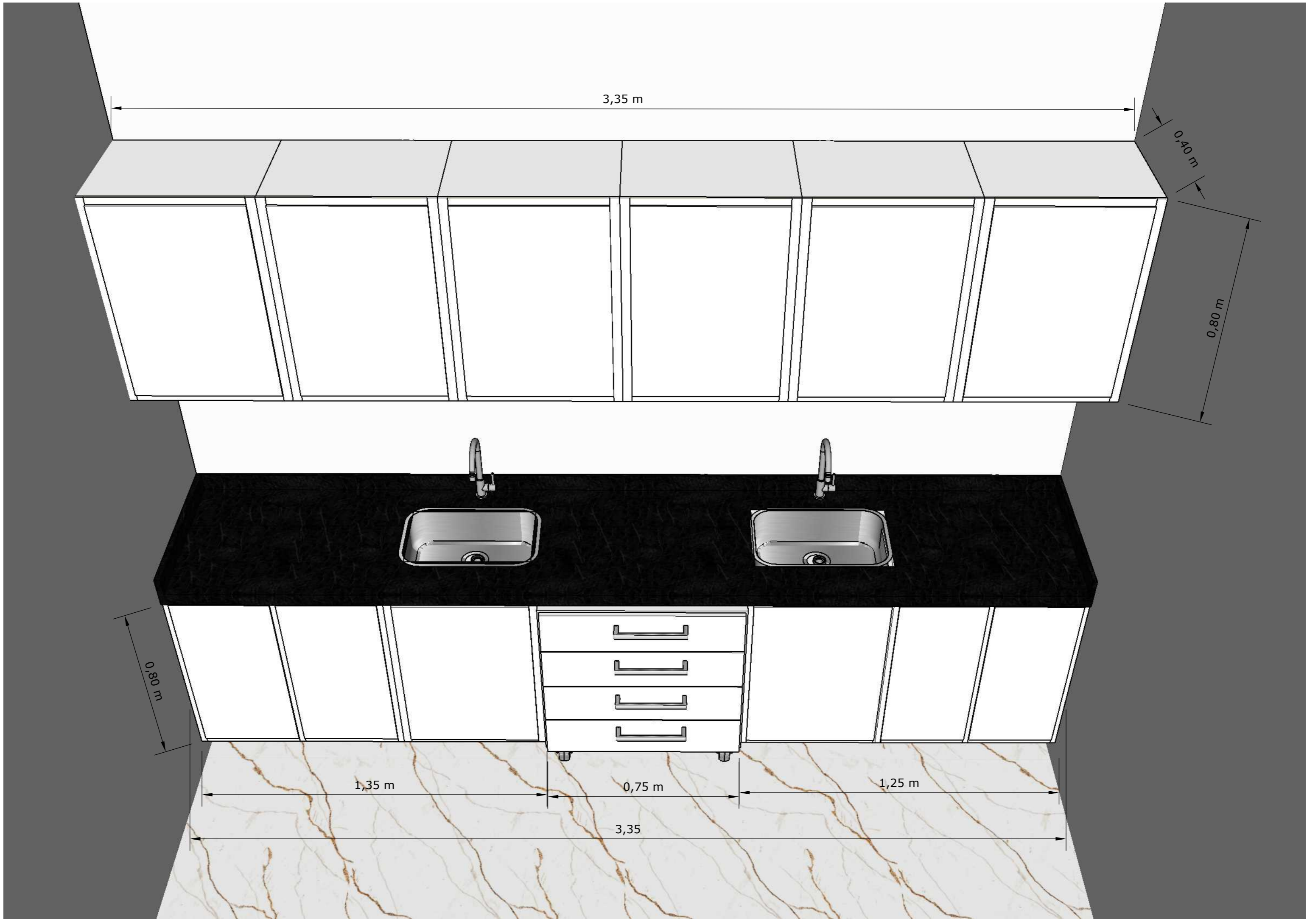

3,35 m

0,40 m

0,80 m

0,80 m

1,35 m

0,75 m

1,25 m

3,35



3,35 m

0,40 m

0,80 m

1,50 m

0,45 m

0,40 m

1,25 m

0,50 m

0,90 m



1,10 m

0,90 m

0,30 m

2,45 m

0,55 m

1,20 m

0,90 m

2,80 m



3,02 m

0,40 m

0,80 m

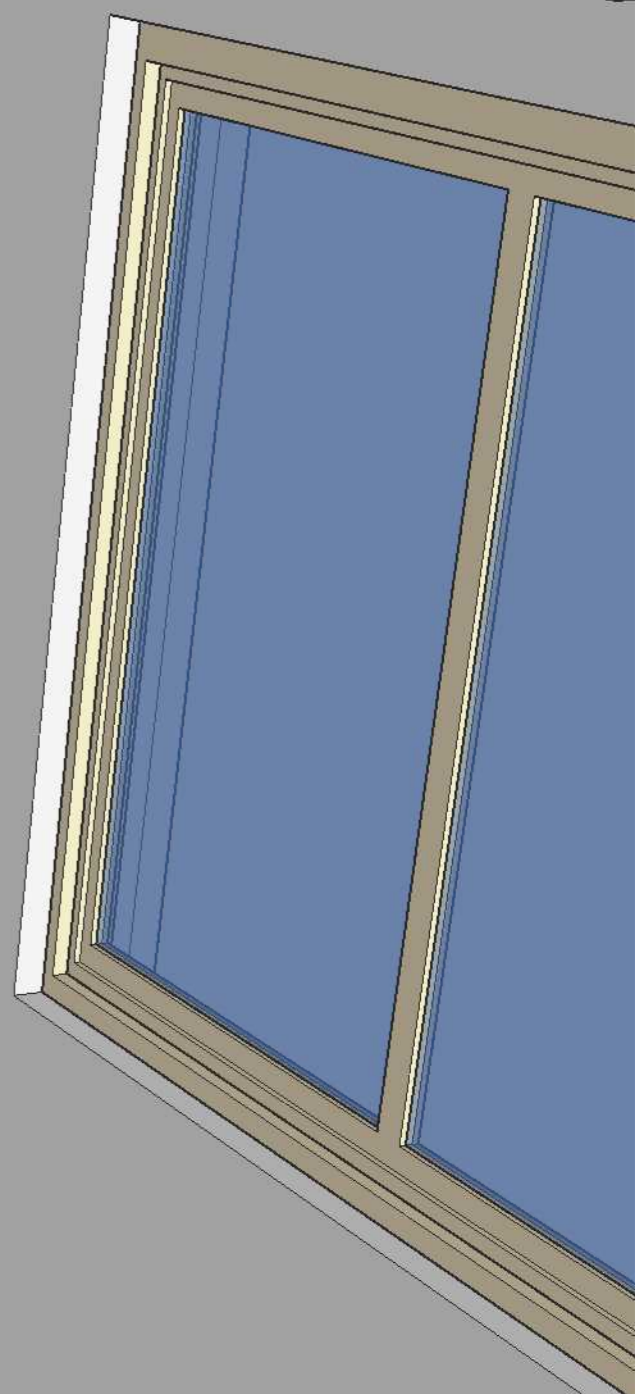
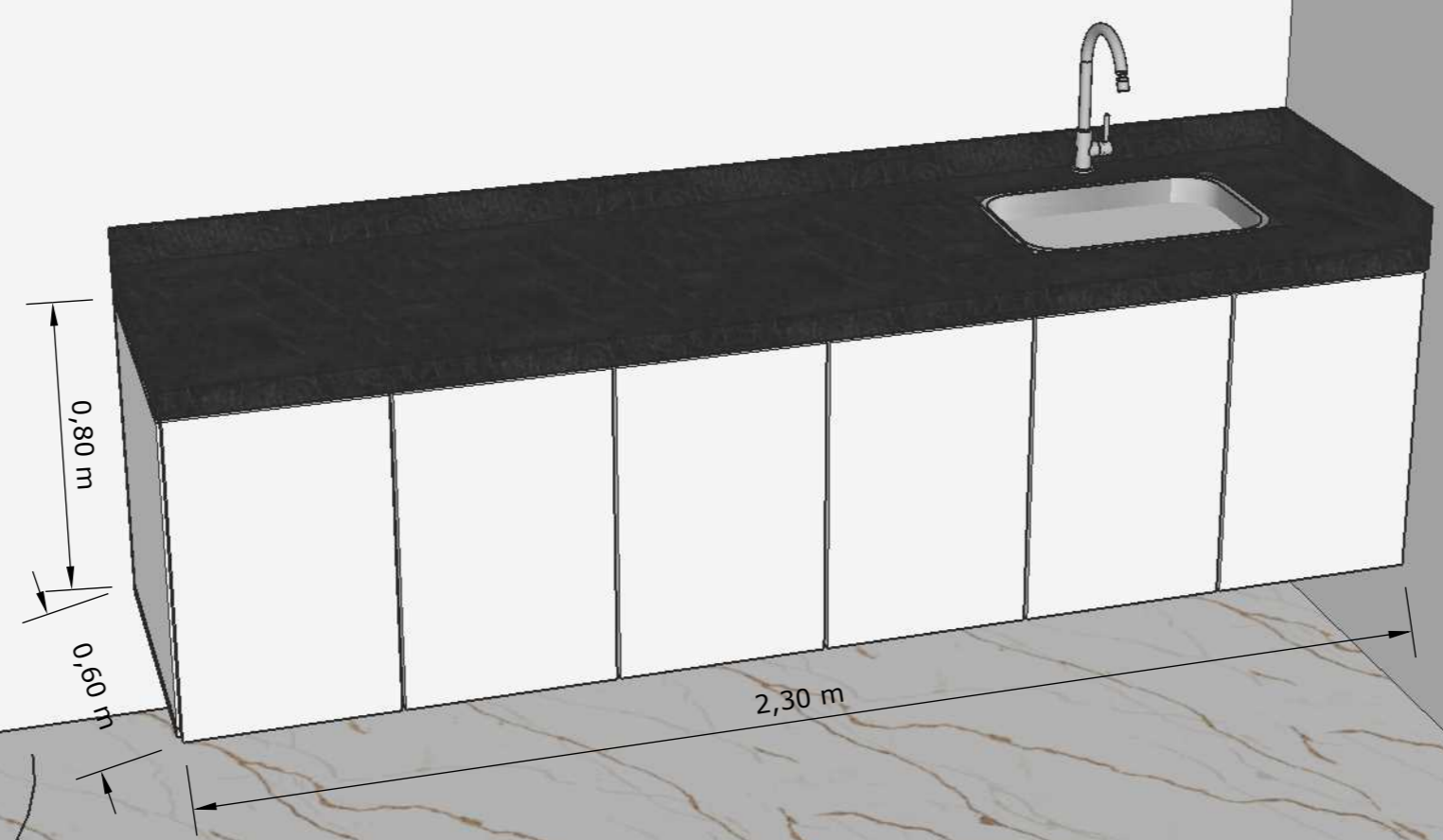
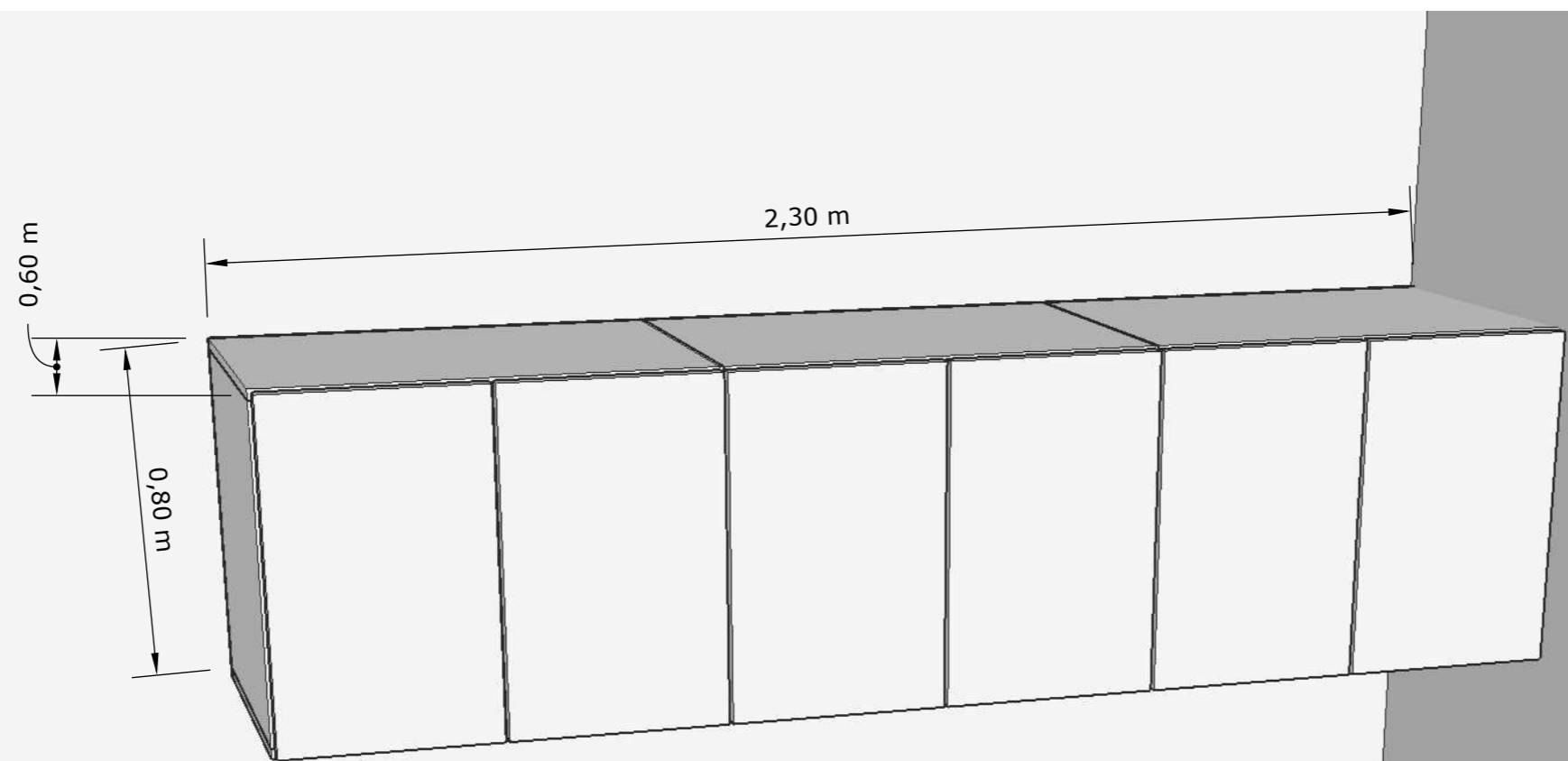



3,35 m

0,40 m

1,35 m

0,40 m

0,80 m

3,35 m

0,40 m

1,35 m

0,96 m

0,50 m







